



Nitsch Engineering

# Supplemental Traffic Impact Study

10 Sunnyside Avenue  
Arlington, MA

December 8, 2022

Prepared for:

Housing Corporation of Arlington  
252 Massachusetts Avenue  
Arlington, MA 02474

Submitted by:

Nitsch Engineering  
2 Center Plaza, Suite 430  
Boston, MA 02108

Nitsch Engineering Project #15289.





## TABLE OF CONTENTS

<b>1</b>	<b>Executive Summary</b> .....	<b>1</b>
1.1	Trip Generation .....	1
1.2	Parking .....	1
1.3	Analysis and Recommendations .....	1
<b>2</b>	<b>Introduction</b> .....	<b>2</b>
2.1	Existing Site and Proposed Development .....	2
2.2	Study Area .....	2
2.3	Methodology.....	5
<b>3</b>	<b>Existing Conditions</b> .....	<b>6</b>
3.1	Roadways .....	6
3.2	Study Intersections.....	6
3.3	Public Transportation .....	7
<b>4</b>	<b>Existing Traffic Conditions</b> .....	<b>8</b>
4.1	Traffic Count Data .....	8
4.2	Seasonal Adjustment .....	8
<b>5</b>	<b>Safety Analysis</b> .....	<b>12</b>
5.1	Crash Data .....	12
5.2	Intersection Crash Rates .....	12
<b>6</b>	<b>Sight Distance</b> .....	<b>14</b>
<b>7</b>	<b>Future No-Build Traffic Conditions</b> .....	<b>16</b>
7.1	Background Growth .....	16
7.2	2029 No-Build Traffic Volumes .....	16
<b>8</b>	<b>Future Build Conditions</b> .....	<b>18</b>
8.1	Proposed Site Changes .....	18
8.2	2029 Build Traffic Volumes .....	18
8.2.1	<i>Proposed Trip Generation</i> .....	18
8.2.2	<i>Project Trip Distribution and Assignment</i> .....	18
<b>9</b>	<b>Parking Generation and Adequacy</b> .....	<b>23</b>
<b>10</b>	<b>Traffic Operations</b> .....	<b>23</b>
10.1	Evaluation Criteria .....	23
10.2	Capacity Analyses.....	24
10.2.1	<i>2022 Existing Conditions Capacity Analysis</i> .....	24
10.2.2	<i>2029 No-Build Conditions Capacity Analysis</i> .....	25
10.2.3	<i>2029 Build Conditions Capacity Analysis</i> .....	26
<b>11</b>	<b>Conclusions and Recommendations</b> .....	<b>28</b>



## LIST OF TABLES

Table 1 – Automatic Traffic Recorder (ATR) Summary .....	8
Table 2 – Crash Statistics .....	12
Table 3 – Crash Rate Summary.....	13
Table 4 – Sight Distance Criteria.....	14
Table 5 – Sight Distance Evaluation .....	15
Table 6 – Peak Hour Trip Generation .....	18
Table 7 – Intersection Level of Service Criteria .....	23
Table 8 – Capacity Analysis Summary: 2022 Existing Conditions .....	25
Table 9 – Capacity Analysis Summary: 2029 No-Build Conditions .....	26
Table 10 – Capacity Analysis Summary: 2029 Build Conditions .....	27

## LIST OF FIGURES

Figure 1: Locus Map.....	3
Figure 2: Study Area Intersections.....	4
Figure 3: 2022 Existing Peak Hour Traffic Volumes .....	9
Figure 4: 2022 Existing Peak Hour Pedestrian Volumes.....	10
Figure 5: 2022 Existing Peak Hour Bicycle Volumes.....	11
Figure 6: 2029 No-Build Peak Hour Traffic Volumes .....	17
Figure 7: Site Generated Trip Distribution.....	20
Figure 8: Site Generated Trip Assignment.....	21
Figure 9: 2029 Build Peak Hour Traffic Volumes.....	22



## 1 Executive Summary

Nitsch Engineering has prepared this Traffic Impact Study (TIS) for the proposed 40B housing development at 10 Sunnyside Avenue in Arlington, Massachusetts. The new development will comprise 43 low-income rental units with approximately 22 parking spaces. The development will also include 70 secured bicycle spaces in the building in addition to the 10 visitor bicycle spaces outside.

### 1.1 Trip Generation

The proposed development is anticipated to generate 207 daily trips, 15 weekday morning peak hour trips, and 20 weekday afternoon peak hour trips. Per the traffic volume data collected at the study area intersections, this does not represent a substantial increase in trips, during both the weekday morning and evening peak hours.

### 1.2 Parking

The Town of Arlington Parking Bylaws require one space per five units of affordable housing. The calculated parking demand for 40 units of affordable housing is 9 spaces. The 22 parking spaces exceeds the minimum nine spaces required by the Town of Arlington Parking Bylaws.

### 1.3 Analysis and Recommendations

We performed a vehicle capacity analysis to compare the weekday morning and weekday evening peak hours of the 2022 Existing conditions, 2029 No-Build conditions, and 2029 Build conditions for the study intersections. Under all conditions, the intersection of Alewife Brook Parkway and Broadway will operate poorly with most of the movements operating at LOS F. However, all movements for the study intersections in Build condition will continue to operate at the same levels of service as No-Build conditions with only minor increases in delay and queuing. The proposed new intersection of Sunnyside Avenue and the Site Driveway will operate at LOS A for all movements.

As the project is not anticipated to have a significant impact to traffic operations at the study intersections, no mitigation is recommended at this time.



## 2 Introduction

Nitsch Engineering has prepared this Traffic Impact Study (TIS) for the proposed 40B housing development at 10 Sunnyside Avenue in Arlington, Massachusetts. The new development will comprise 43 low-income rental units with approximately 22 parking spaces. The development will also include 70 secured bicycle spaces in the building in addition to the 10 visitor bicycle spaces outside.

This TIS will review existing roadway conditions, crash data, and traffic volumes, and it will analyze existing and future conditions at intersections in the study area to establish the impact the proposed development would have on traffic operations.

Figure 1 shows the Locus Map and Figure 2 shows the study area intersections.

### 2.1 Existing Site and Proposed Development

The project site, comprising approximately 16,500 square feet of land area, was previously occupied by an approximate 5,400-square-foot Automotive Center with an unstriped surface parking lot. The site is bounded by a commercial property to the north, an adult use marijuana dispensary to the south, Sunnyside Avenue to the east, and a commercial parking lot to the west.

The proponent proposes to modify and expand the existing site to develop 43 low-income residential units on site with approximately 22 parking spaces. Access to the site will remain as existing; one curb cut off Sunnyside Avenue.

### 2.2 Study Area

The study area includes the existing main three roadways, and three intersections within and adjacent to the project site.

#### **Roadways**

- Alewife Brook Parkway (Route 16)
- Broadway
- Sunnyside Avenue

#### **Intersections**

- Alewife Brook Parkway (Route 16) and Broadway (Signalized)
- Sunnyside Avenue and Broadway (Unsignalized)
- Sunnyside Avenue and Site Driveway (Unsignalized)





**Figure 1: Locus Map**  
10 Sunnyside Avenue  
Arlington, MA

Data Source: BingMaps  
Nitsch Project #: 15289





**Figure 2: Study Area Intersections**

10 Sunnyside Avenue  
 Arlington, MA

Data Source: BingMaps  
 Nitsch Project #: 15289





## 2.3 Methodology

The traffic analysis herein is summarized in the following sections:

1. An inventory of existing transportation conditions, including roadway capacities, parking, transit, pedestrian and bicycle circulation, and site conditions.
2. An evaluation of future transportation conditions and an assessment of potential traffic impacts associated with the Project and other neighboring projects. Long-term impacts are evaluated for the year 2029, based on a seven-year horizon from the 2022 base year. Expected roadway conditions and deficiencies are identified. This section includes the following scenarios:
  - a. The No-Build Scenario (2029) includes general background growth and additional vehicular traffic associated with specific proposed or planned developments and roadway changes in the vicinity of the Project site; and
  - b. The Build Scenario (2029) includes specific travel demand forecasts for the Project.



## 3 Existing Conditions

### 3.1 Roadways

#### ***Alewife Brook Parkway (Route 16)***

Alewife Brook Parkway is classified as an Urban Principal Arterial under Department of Conservation and Recreation (DCR) jurisdiction. It runs in an approximate north-west direction and spans approximately 2.0 miles from its northern terminus at Mystic Valley Parkway to its southern terminus at Concord Avenue. Within the study area, Alewife Brook Parkway is approximately 38 feet wide and is a two-way, four-lane roadway carrying two lanes of travel in each direction. Parking is prohibited on both sides of the roadway along its entire length. Along the west side of the roadway from Mystic Valley Parkway to Massachusetts Avenue, there is a separated multi-use path. On the west side of the roadway, the Alewife Greenway Bikeway runs parallel to the roadway from Mystic Valley Parkway to Concord Parkway. On the east side of the roadway, there is a separated shared-use path from Massachusetts Avenue to Woodstock Street and again from Broadway to Mystic Valley Parkway. The posted speed limit on Alewife Brook Parkway is 30 miles per hour (mph).

#### ***Broadway***

Broadway is classified as an Urban Principal Arterial under local jurisdiction. Broadway generally runs in an east-west direction and provides one travel lane in each direction. Within the study area, Broadway generally provides two 11- to 12-foot-wide travel lanes separated by a double-yellow centerline with no marked shoulders and parking provided intermittently along both sides. Sidewalks are provided along both sides of Broadway within the study area, with illumination provided by way of streetlights mounted on wood poles. The posted speed limit along Broadway is 25 mph. Land use within the study area consists of the Saint Paul's Cemetery and residential and commercial properties.

#### ***Sunnyside Avenue***

Sunnyside Avenue is classified as a Local Access Roadway under local jurisdiction. Sunnyside Avenue generally runs in a north-south direction and provides one travel lane in each direction. Within the study area, Sunnyside Avenue provides an approximate 26-foot wide traveled-way with no marked centerline or shoulders provided and on-street parking permitted along both sides of the roadway. Sidewalks are provided along both sides of Sunnyside Avenue within the study area, with illumination provided by way of streetlights mounted on wood poles. A posted speed limit is not provided along Sunnyside Avenue and, as such, the statutory speed limit is 25 mph. Land use within the study area consists of residential and commercial properties.

### 3.2 Study Intersections

#### ***Alewife Brook Parkway (Route 16) and Broadway***

The intersection of Alewife Brook Parkway (Route 16) and Broadway is a four-way, signalized intersection with Alewife Brook Parkway running north-south and Broadway running east-west. Both Alewife Brook Parkway approaches carry two approach lanes: one left-turn/through lane and one through/right-turn lane. Both Broadway approaches are striped as one left-turn/through/right-turn lane in each direction, but both act as two lanes: one left-turn/through lane and one through/right-turn lane. The Alewife Brook Parkway movements have their own phase, followed by an exclusive pedestrian phase, followed by the Broadway eastbound phase, and then the Broadway



westbound phase. There is a shared-use path on the north side of Alewife Brook Parkway at the intersection. Sidewalks are present at all approaches to the intersection and there are crosswalks present across all approaches.

### ***Sunnyside Avenue and Broadway***

The intersection of Sunnyside Avenue and Broadway is a three-way, unsignalized intersection with Broadway operating as a free movement through the intersection and Sunnyside Avenue under stop-control. Sunnyside Avenue runs north-south and Broadway runs east-west. Both the Sunnyside Avenue and Broadway approaches carry one approach lane. Note that the Broadway approach lanes are 22 feet wide and although are only striped as single lanes, they operate as two approach lanes to provide queuing storage for vehicles turning onto Sunnyside Avenue. Sidewalks are present at all approaches to the intersection however crosswalks are not present. Wheelchair ramps with detectable warning panels are provided at the northeast and northwest corners of the intersection.

### ***Sunnyside Avenue and the Existing Site Driveway***

The intersection of Sunnyside Avenue and the Site Driveway is a three-way, unsignalized intersection with Sunnyside Avenue operating as a free movement through the intersection. Sunnyside Avenue runs north-south and the Site Driveway runs east-west. Both the Sunnyside Avenue and Broadway approaches carry one approach lane. Sidewalks are present along both sides of Sunnyside Avenue.

## **3.3 Public Transportation**

Public transportation services are provided within the study area by the Massachusetts Bay Transit Authority (MBTA) for Bus service. Within the study area, the MBTA operates the Route 87 – Clarendon Hill or Arlington Center - Lechmere Station. Route 87 stops at the Broadway/Sunnyside Avenue intersection; and provides a connection to Arlington Center, Clarendon Hill, Teele Square, Davis Station (MBTA Subway Red Line), Union Square, and Lechmere Station (MBTA Subway Green Line).

MBTA bus service operates Monday through Friday from approximately 5:07 AM to 1:40 AM, on Saturday from 5:15 AM to 1:35 AM, and on Sunday from 6:00 AM to 1:33 AM, with 30-minute-or-less headways on weekdays and Saturdays and 60-minute-or-less headways on Sundays. All MBTA buses are handicapped and wheelchair accessible.

## 4 Existing Traffic Conditions

### 4.1 Traffic Count Data

#### Turning Movement Count (TMC) Data

We retained Accurate Counts (AC) of North Reading, Massachusetts to collect traffic data within the study area, including both Automatic Traffic Recorder (ATR) counts and Turning Movement Counts (TMCs).

#### ATR Data

AC collected ATR counts for a continuous 48-hour period on Broadway between Sunnyside Avenue and Alewife Brook Parkway from Wednesday, November 2 to Thursday, November 3, 2022. We summarize the seasonally adjusted ATR counts in Table 1. (Section 4.2 discusses seasonal adjustment.) The original ATR data is included in Appendix A.

**Table 1 – Automatic Traffic Recorder (ATR) Summary**

Location	Period	ADT <sup>a</sup>		Peak Hour Traffic			K Factor <sup>e</sup>
		Volumes (vpd) <sup>b</sup>	Directional Distribution <sup>c</sup>	Period	Volumes (vph) <sup>d</sup>	Directional Distribution <sup>c</sup>	
Broadway, east of Sunnyside Avenue	Weekday	8,807	56% EB	Morning	628	55% EB	0.07
				Afternoon	772	54% EB	0.09

<sup>a</sup>Average Daily Traffic; <sup>b</sup>Vehicles per day; <sup>c</sup>NB = Northbound, SB = Southbound, EB = Eastbound, WB = Westbound; <sup>d</sup>Vehicles per hour; <sup>e</sup>Proportion of daily traffic

#### TMC Data

AC collected TMC data at the two study intersections on Thursday, November 3, 2022. TMC data was recorded from 7:00 AM to 9:00 AM to capture the weekday morning traffic peak hours and from 4:00 PM to 6:00 PM to capture the weekday afternoon traffic peak hours. The counts included passenger vehicles, heavy vehicles, bicycles, and pedestrians. The peak hours within the study area were established as 7:00 AM to 8:00 AM during the morning period, and 5:00 PM to 6:00 PM during the afternoon period. The TMC data is included in Appendix A.

### 4.2 Seasonal Adjustment

Nitsch Engineering used the MassDOT 2019 Weekday Seasonal Adjustment Factors to establish if the traffic counts needed to be seasonally adjusted. The composition of the study area falls within “Group U4-7 Urban Arterials.” Counts within Group U4-7 collected during the month of November experience a value that is approximately 1% higher than an average month. Therefore, no seasonal adjustment factors were applied.

Figure 3 through 5 shows the 2022 existing peak-hour vehicular traffic, pedestrian, and bicycle volumes at the study intersections in the form of turning movements.



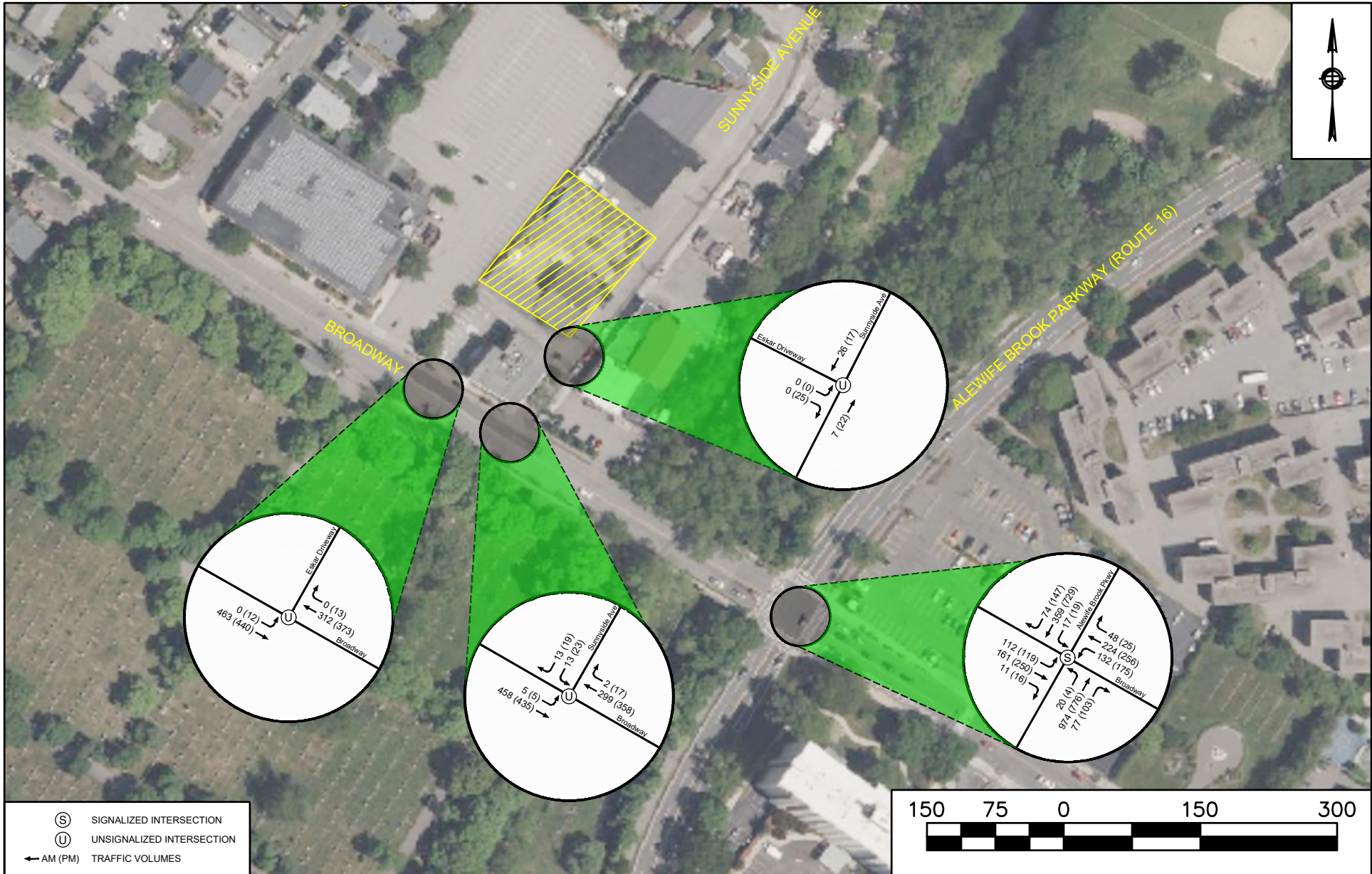
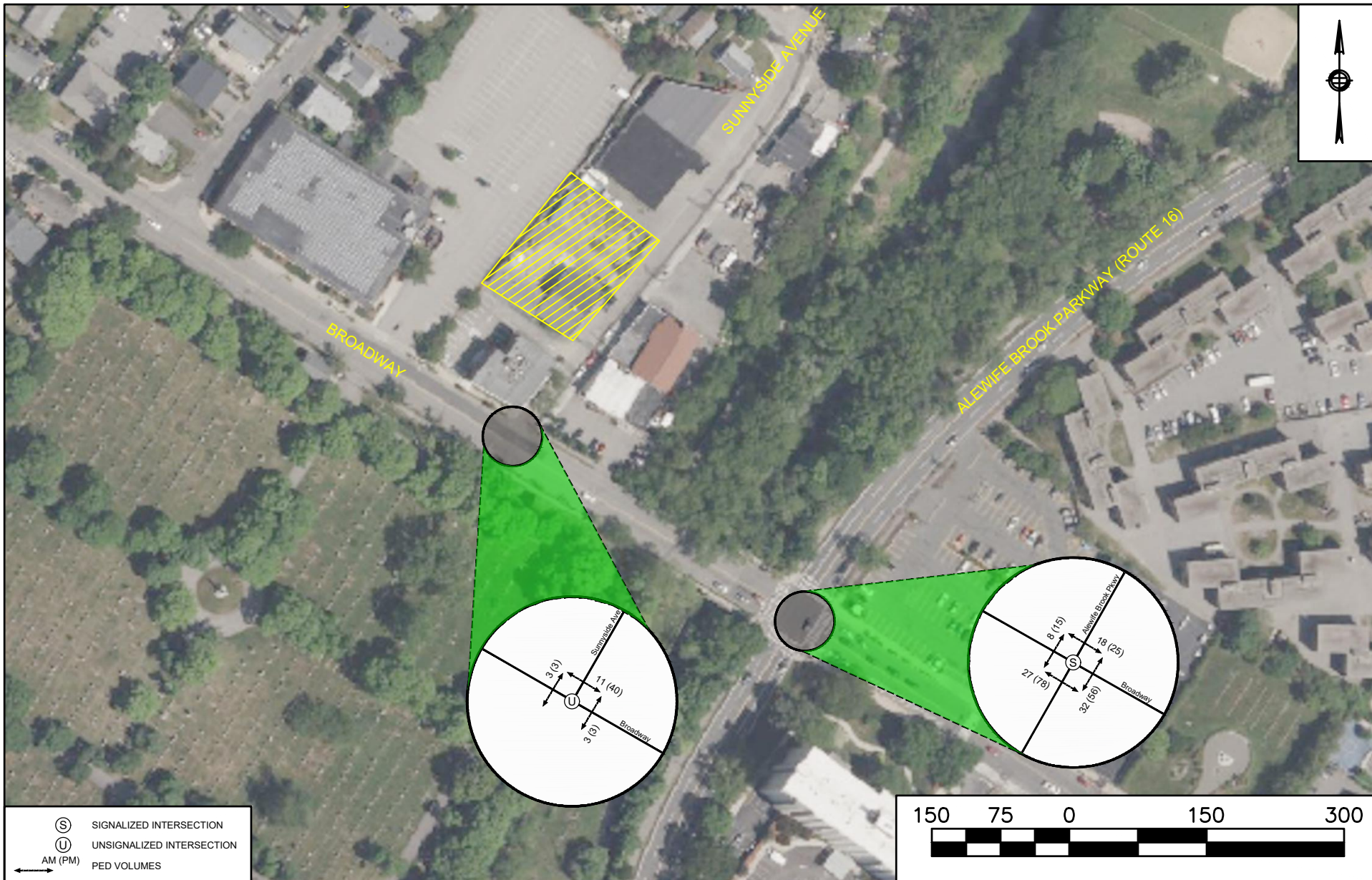

**Figure 3: 2022 Existing Peak Hour Traffic Volumes**

10 Sunnyside Avenue  
Arlington, MA

Data Source: BingMaps  
Nitsch Project #: 15289



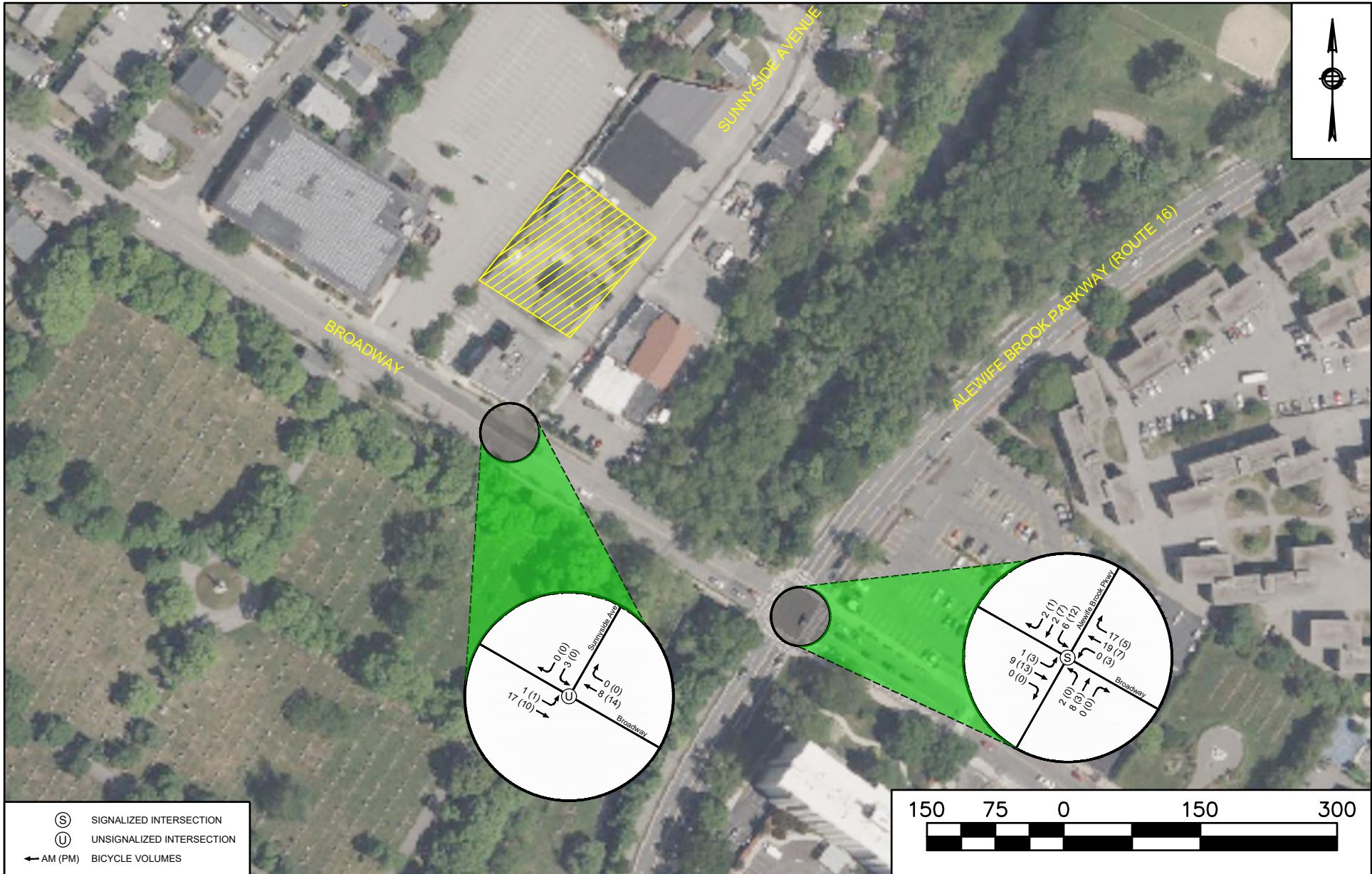

**Figure 4: 2022 Existing Peak Hour Pedestrian Volumes**

10 Sunnyside Avenue  
Arlington, MA

Data Source: BingMaps  
Nitsch Project #: 15289





**Figure 5: 2022 Existing Peak Hour Bicycle Volumes**

10 Sunnyside Avenue  
Arlington, MA

Data Source: BingMaps  
Nitsch Project #: 15289

## 5 Safety Analysis

### 5.1 Crash Data

We obtained crash data for the study intersections from MassDOT's IMPACT Crash Data Portal for the five most recent complete years of data, 2015 through 2019. Table 2 summarizes the crash statistics for the two study-area intersections.

**Table 2 – Crash Statistics**

Location	Number of Crashes			Severity				Manner of Collision					Percent During	
	Year	Total Crashes	Annual Average	PD <sup>a</sup>	PI <sup>b</sup>	NR <sup>c</sup>	F <sup>d</sup>	A <sup>e</sup>	RE <sup>f</sup>	SS <sup>g</sup>	Other <sup>h</sup>	Incl. Ped-Bike <sup>i</sup>	Peak Hours <sup>k</sup>	Wet/Icy Conditions
Sunnyside Avenue at Broadway	2015	2	0.4	2	0	0	0	1	1	0	0	0	100%	50%
	2016	0		0	0	0	0	0	0	0	0	0	0%	0%
	2017	0		0	0	0	0	0	0	0	0	0	0%	0%
	2018	0		0	0	0	0	0	0	0	0	0	0%	0%
	2019	0		0	0	0	0	0	0	0	0	0	0%	0%
	<b>TOTAL</b>	<b>2</b>		<b>2</b>	<b>2</b>	<b>0</b>	<b>0</b>	<b>0</b>	<b>0</b>	<b>1</b>	<b>1</b>	<b>0</b>	<b>0</b>	<b>0</b>
Broadway at Alewife Brook Parkway	2015	6	11.2	4	2	0	0	3	1	0	2	0	17%	33%
	2016	16		10	5	1	0	12	1	1	2	0	13%	13%
	2017	13		9	4	0	0	6	2	4	1	1	46%	15%
	2018	11		8	3	0	0	7	2	2	0	1	10%	0%
	2019	10		3	6	0	1	7	0	1	2	1	20%	0%
	<b>TOTAL</b>	<b>56</b>		<b>34</b>	<b>20</b>	<b>1</b>	<b>1</b>	<b>35</b>	<b>6</b>	<b>8</b>	<b>7</b>	<b>3</b>	<b>23%</b>	<b>11%</b>

<sup>a</sup>Property Damage Only; <sup>b</sup>Personal Injury Only (non-Fatal Injury); <sup>c</sup>Not Reported; <sup>d</sup>Fatality; <sup>e</sup>Angle; <sup>f</sup>Rear-end; <sup>g</sup>Sideswipe (same direction); <sup>h</sup>Sideswipe (opposite direction), Head-on, Single-Vehicle, Rear-to-Rear, Not Reported, Unknown, etc.; <sup>i</sup>Includes pedestrian or cyclist; <sup>k</sup>Occurred between 7-9am or 4-6pm

A total of 58 crashes were reported within the study area from 2015 to 2019. In terms of severity, 36 crashes reported property damage only, one crash had no severity reported, and another 20 crashes reported personal injury with one of them involving a fatality. Angle crashes were the most frequent type of crash with a total of 36 crashes, and of the remaining crashes, seven were rear-end, eight were sideswipes between vehicles traveling in the same direction, two were single-vehicle crashes, and five were head-on collisions. Three crashes involved pedestrians. 23% of all crashes in the study area occurred during peak hours, and 11% of all crashes occurred under wet conditions.

### 5.2 Intersection Crash Rates

The intersection crash rate is recognized as an effective tool to measure the safety of intersections. Crash rates for intersections are expressed by the number of crashes per million entering vehicles (MEV). Table 3 compares the crash rates for the study intersections with the Statewide and MassDOT District averages, as appropriate. The intersection crash rate calculations are included in Appendix D.



**Table 3 – Crash Rate Summary**

Location	Facility Type	Number of Crashes <sup>a</sup>	Crash Rate <sup>b</sup>	Average Rates <sup>b,c</sup>		Comparison to Average Rates	
				District 4	Statewide	District 4	Statewide
Sunnyside Avenue at Broadway	Unsignalized Intersection	2	0.10	0.57	0.57	Below	Below
Broadway at Alewife Brook Parkway	Signalized Intersection	56	1.09	0.73	0.78	Above	Above
<sup>a</sup> Based on 5-year crash history from MassDOT, 2014-2018 <sup>b</sup> Crashes per million entering vehicles (MEV), <sup>c</sup> Based on the full set of MassDOT crash database entries as queried June 2018							

Based on Tables 2 and 3, the intersection of Alewife Brook Parkway and Broadway experienced a high frequency of crashes over the five-year review period with a total of 56 crashes reported at the intersection, averaging 11.2 crashes per year. The intersection was found to have a motor vehicle crash rate of 1.09 crashes per MEV, which is above both the Statewide average and the MassDOT District 4 average, where the Project is located. In addition, the Highway Safety Improvement Program (HSIP) database was reviewed. The intersection of Alewife Brook Parkway and Broadway is listed as a HSIP cluster in the most recent (2015-2017) HSIP cluster listing.

The crash rate at the intersection of Sunnyside Avenue at Broadway is well below both the MassDOT District 4 and Statewide averages.

## 6 Sight Distance

Stopping Sight Distance (SSD) is the length of the roadway ahead that is visible to the driver and should be long enough to enable a vehicle traveling at or near the design speed to stop before reaching a stationary object in its path. Stopping sight distance is the sum of the distance traversed by the vehicle from the instant the driver sights an object necessitating a stop to the instant the brakes are applied and the distance needed to stop the vehicle from the instant brake application begins.

Intersection Sight Distance (ISD) is the length of the leg of the departure sight triangle along the major road in both directions for a vehicle stopped on the minor road waiting to depart. The critical departure sight triangles for the proposed site driveway are for traffic approaching from either the left or right for left turns from driveway onto Sunnyside Avenue. The SSD and ISD values associated with a given design speed are shown in Table 4.

**Table 4 – Sight Distance Criteria**

DESIGN SPEED (MPH)	DESIGN STOPPING SIGHT DISTANCE VALUE <sup>1</sup> (FT)	RECOMMENDED INTERSECTION SIGHT DISTANCE VALUE <sup>2</sup> (FT)
15	80	170
20	115	225
25	155	280
30	200	335
35	250	390
40	305	445
45	360	500
50	425	555
55	495	610
60	570	665
65	645	720
70	730	775
75	820	830
80	910	885
<i>Source: A Policy on Geometric Design of Highways and Streets, AASHTO, Washington DC (2011)</i>		
<sup>1</sup> Design value based on a grade of less than 3%, a brake reaction distance predicted on a time of 2.5 seconds and a deceleration rate of 11.2 ft/s <sup>2</sup>		
<sup>2</sup> Recommended value based on Case B1 - a stopped passenger car to turn left onto a two-lane highway with no median and grades 3% or less		

Using the statutory speed limit of 25 MPH for Sunnyside Avenue, we calculated the required sight distance at the Site Driveway. As shown in Table 5, both SSD and ISD values at the Site Driveway are sufficient to meet current traffic engineering standards.

**Table 5 – Sight Distance Evaluation**

Intersecting Street	Stopping Sight Distance (SSD)			Intersection Sight Distance (ISD)		
	Traveling	Calculated	Measured	Looking	Calculated	Measured
Site Driveway at Sunnyside Avenue	NB	155	180	Right	280	210 <sup>a</sup>
	SB	155	310	Left	280	280
<sup>a</sup> Clear line of sight provided to Broadway						



## 7 Future No-Build Traffic Conditions

Nitsch Engineering used the 2022 existing traffic volumes as the baseline for projecting traffic volumes to future 2029 No-Build conditions. To determine future 2029 conditions, the following steps are included:

- Project existing 2022 traffic volumes seven years in the future to the horizon year (2029) using an annual background traffic growth factor to account for regional growth;
- Add traffic volumes associated with any planned developments that may impact the study area;
- Include any planned roadway improvements that may affect traffic volumes; and
- Analyze the study area location to determine future traffic operations.

### 7.1 Background Growth

We reviewed the Town of Arlington's 2015 Master Plan to determine an appropriate growth rate to apply to the 2022 existing traffic volumes. As noted in Table 2.1 in Chapter 2 of the Master Plan, the expected growth from 2020 to 2030 is 3.3%, which equates to an annual 0.33% background growth rate. Understanding that development is increasing in the Greater Boston Area, we selected a conservative rate of 2.0% per year to represent regional background growth of traffic, as well as accounting for any additional development in this area. We applied this growth rate over the 7-year design period for the turning movement data.

### 7.2 2029 No-Build Traffic Volumes

We developed the 2029 No-Build volumes by applying annual growth rates for seven years to the 2022 Existing conditions volumes turning movements at the three study intersections. Figure 6 presents the peak hour traffic volumes for 2029 No-Build conditions.



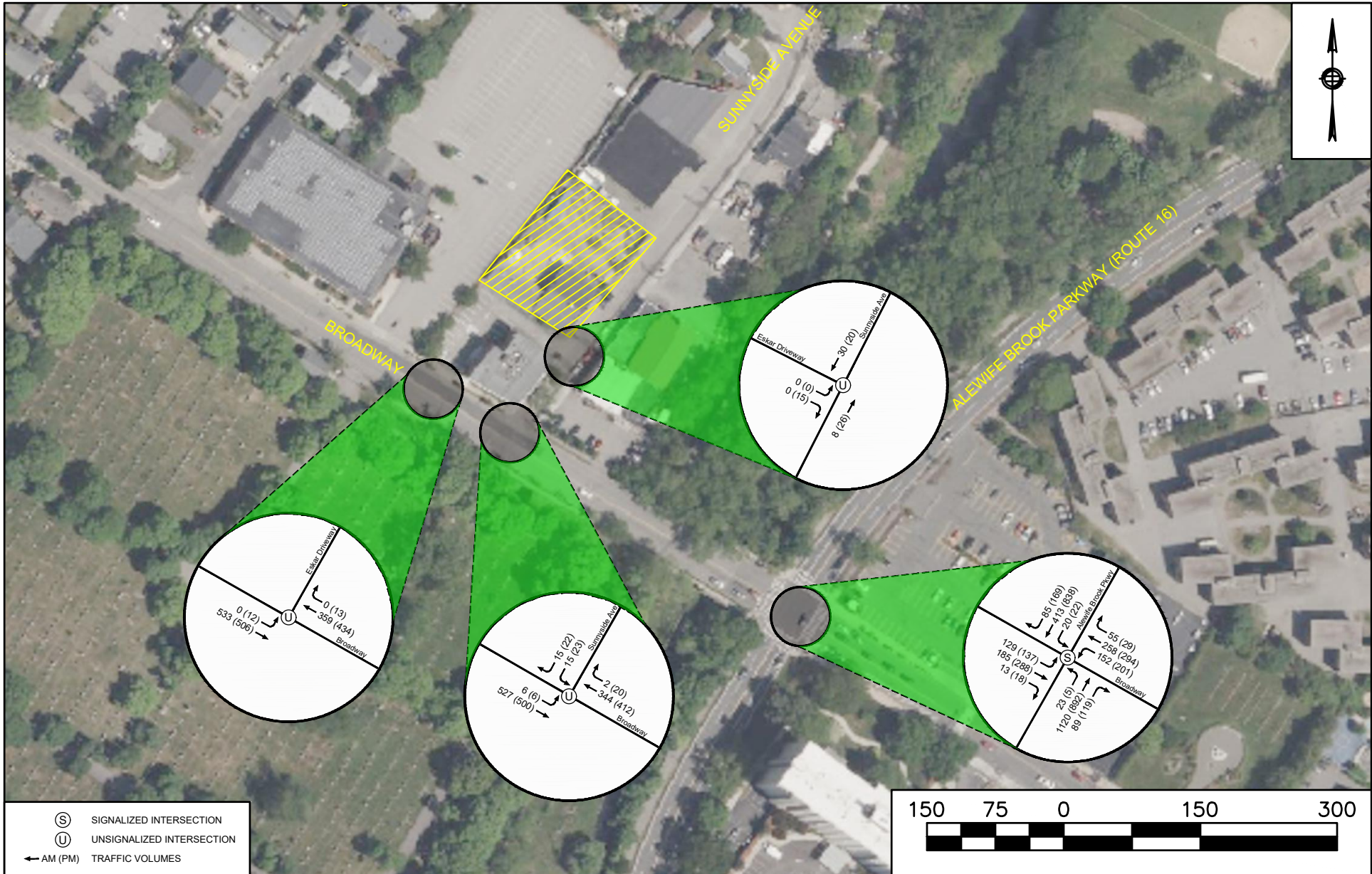

**Figure 6: 2029 No-Build Peak Hour Traffic Volumes**

10 Sunnyside Avenue  
Arlington, MA

Data Source: BingMaps  
Nitsch Project #: 15289

## 8 Future Build Conditions

### 8.1 Proposed Site Changes

The proponent proposes to modify and expand the existing site to develop 43 low-income residential units on site with approximately 22 parking spaces. The development will also include 70 secured bicycle spaces in the building in addition to the 10 visitor bicycle spaces outside. The development will also include 70 secured bicycle spaces in the building in addition to the 10 visitor bicycle spaces outside.

Access to the site will remain as existing; one curb cut off Sunnyside Avenue.

### 8.2 2029 Build Traffic Volumes

The 2029 Build traffic volumes comprise the 2029 No-Build volumes and the vehicle trips generated by the proposed development. The individual turning movements were applied to the study intersections.

#### 8.2.1 Proposed Trip Generation

We estimated the trip generation for the proposed land use to obtain the trips generated by the proposed Project using the Institute of Transportation Engineers (ITE) *Trip Generation, 11<sup>th</sup> Edition*.<sup>1</sup> For the new affordable housing complex, we used LUC 223 – “Affordable Housing”, which includes all multifamily housing that is rented at below market rate to households that include at least one employed member. Eligibility to live in affordable housing can be a function of limited household income and resident age. As the existing land use did not generate any trips during the count periods, a trip generation credit was not applied. The total future trips are shown in Table 6.

**Table 6 – Peak Hour Trip Generation**

Period	Direction	Future Peak Hour Trips
		Apartment Trips
Weekday	Enter	103
	Exit	104
	<b>Total</b>	<b>207</b>
Weekday morning	Enter	4
	Exit	11
	<b>Total</b>	<b>15</b>
Weekday evening	Enter	12
	Exit	8
	<b>Total</b>	<b>20</b>

Detailed trip generation calculations are provided in Appendix C.

#### 8.2.2 Project Trip Distribution and Assignment

The traffic volume to and from the proposed development site will be distributed and assigned for the weekday morning and weekday evening peak hours based on the existing travel patterns and logical travel routes, which

<sup>1</sup> *Trip Generation*, Institute of Transportation Engineers, 11th Edition, 2021, Washington, D.C.



are based on the existing roadway network both within the Town and the surrounding region. The Trip Distribution percentages specific to the development are shown in Figure 7.

To distribute the site generated traffic volume through the roadway network, the volumes in Table 6 were multiplied by the trip distribution percentages assigned to the intersection volumes. The site-generated traffic volumes are shown on Figure 8 for the weekday morning and weekday evening peak hours.

The Build Condition traffic volumes were calculated by combining the No-Build traffic volumes with the site-generated traffic volumes, which are shown on Figure 9.



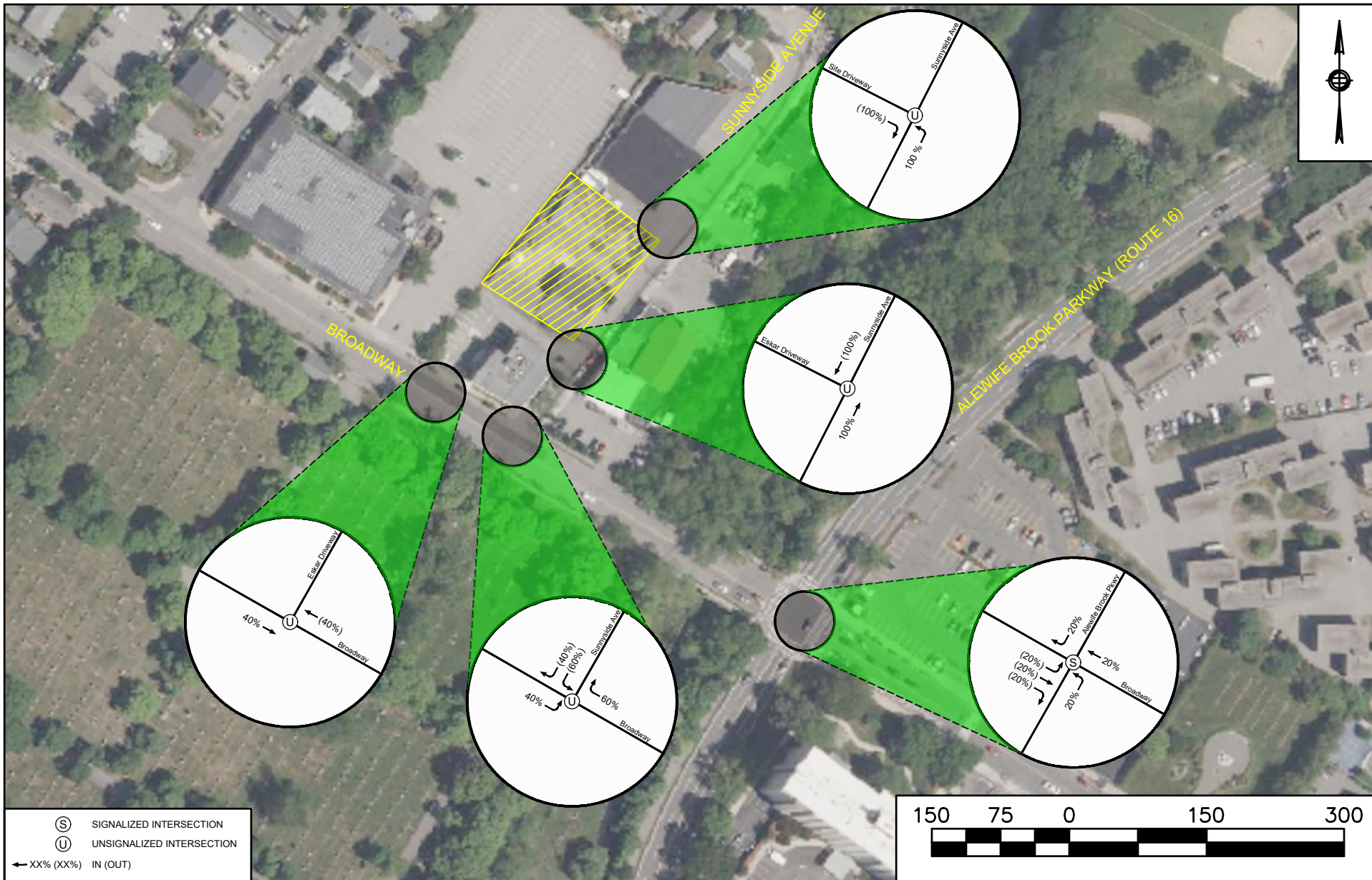
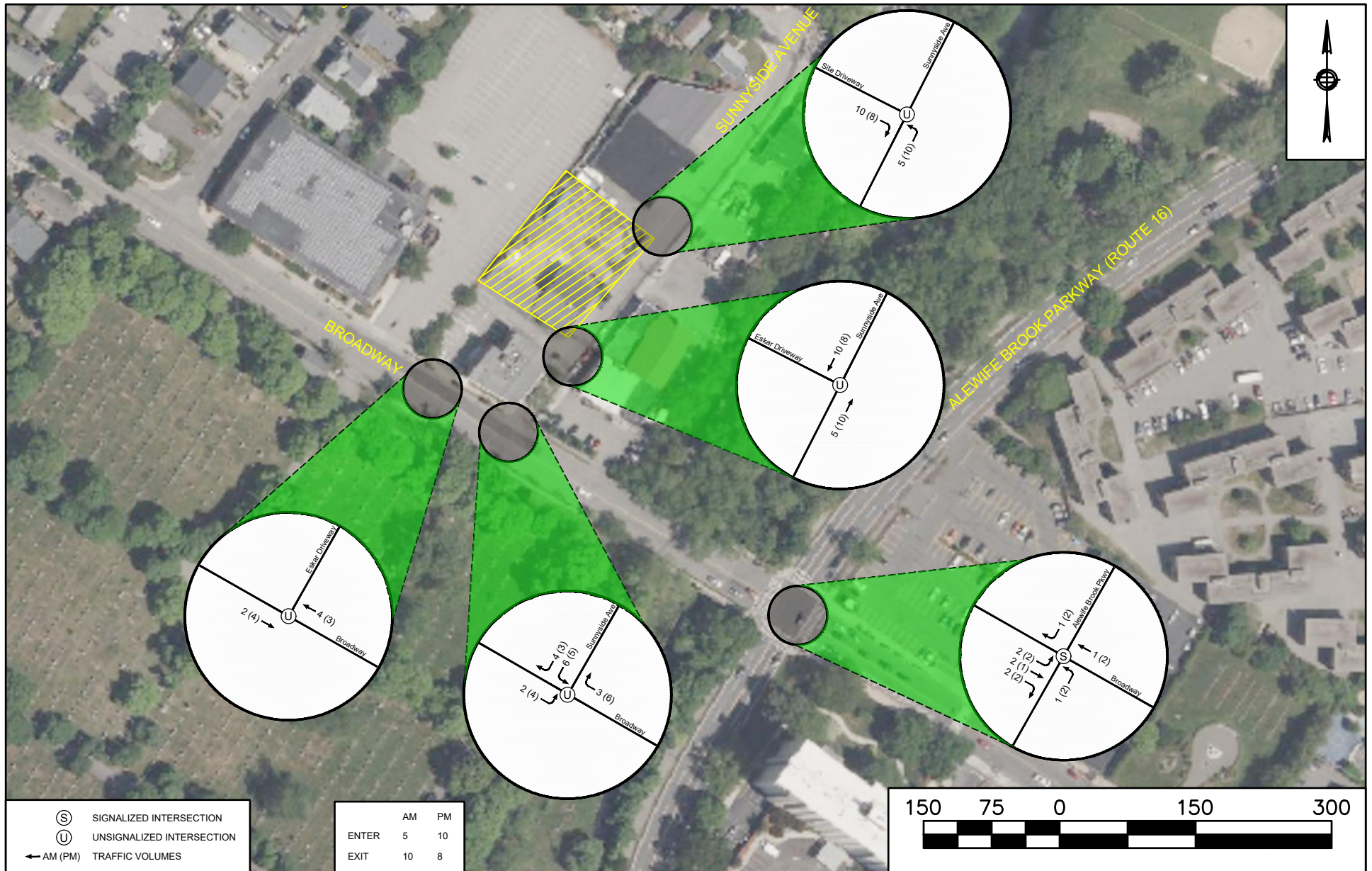

**Figure 7: Site Generated Trip Distribution**

10 Sunnyside Avenue  
Arlington, MA

Data Source: BingMaps  
Nitsch Project #: 15289



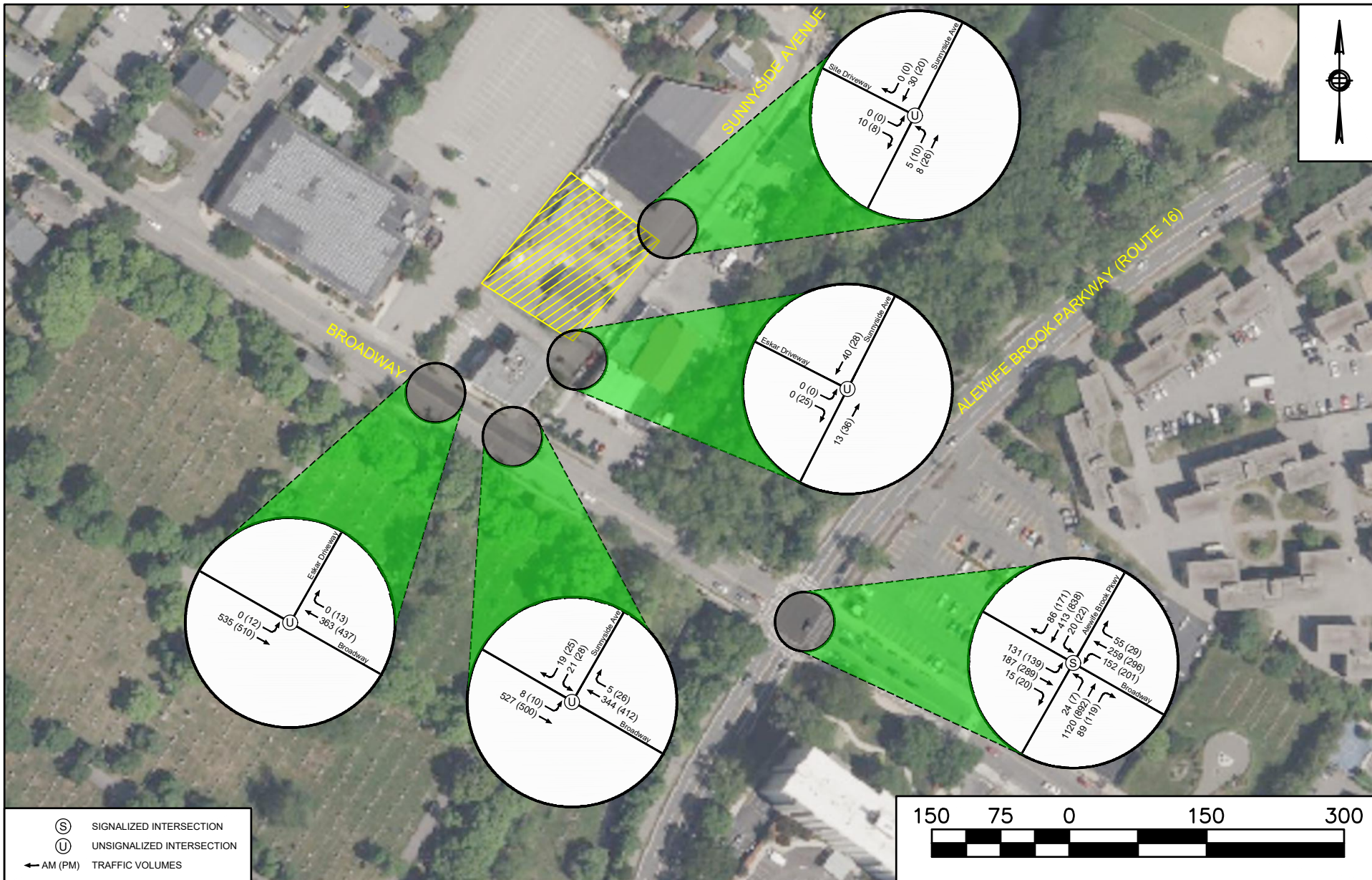

**Figure 8: Site Generated Trip Assignment**

10 Sunnyside Avenue  
Arlington, MA

Data Source: BingMaps  
Nitsch Project #: 15289





**Figure 9: 2029 Build Peak Hour Traffic Volumes**

10 Sunnyside Avenue  
Arlington, MA

Data Source: BingMaps  
Nitsch Project #: 15289

## 9 Parking Generation and Adequacy

Nitsch Engineering reviewed the Town of Arlington Zoning Bylaws to determine the required number of parking spaces for the development and assess adequacy of the proposed spaces.

The Town of Arlington Parking Bylaws requires a minimum of one space per five units of affordable housing. The calculated parking demand for 43 units of an affordable housing is 9 spaces.

Therefore, the proposed 22 parking spaces exceeds the minimum nine spaces required by the Town of Arlington Parking Bylaws.

## 10 Traffic Operations

### 10.1 Evaluation Criteria

Traffic operations at intersections are evaluated using the performance measures of average vehicular delay, level of service (LOS), volume-to-capacity (v/c) ratio, and average and 95th percentile queue lengths.

LOS is a qualitative measure that describes operating conditions through letter designations, from A to F. It is defined for intersections in terms of average control delay per vehicle. LOS A indicates the most favorable condition, with minimum traffic delay. LOS F represents the worst condition where there is significant traffic delay. LOS D or better is typically considered desirable for peak-hour operation in urban and suburban settings. The delay designations for each LOS level differ slightly between signalized and unsignalized intersections due to driver expectations and behavior. Table 7 summarizes the LOS criteria for intersections as used in this analysis.

**Table 7 – Intersection Level of Service Criteria**

Level of Service	Average Control Delay (sec/veh)	
	Signalized	Unsignalized
A	0-10	0-10
B	>10-20	>10-15
C	>20-35	>15-25
D	>35-55	>25-35
E	>55-80	>35-50
F	>80	>50

Source: HCM 2000

For signalized intersections, LOS is reported by lane group, by approach, and for the entire intersection. For unsignalized intersections, the analysis assumes that the traffic on the mainline is not affected by traffic on the side street. As such, an unsignalized intersection's LOS is generally reported for left-turns on the mainline and all side street movements, and an overall intersection LOS is not determined.

The v/c ratio is a measure of congestion at an intersection approach. The capacity of a facility is the maximum hourly rate at which persons or vehicles reasonably can be expected to traverse a point or a uniform section of a lane or roadway under prevailing roadway, traffic, and control conditions. A v/c ratio below one indicates that the



intersection approach has adequate capacity to serve the arriving traffic demand. A v/c ratio that approaches or exceeds 1.0 indicates traffic congestion or poor operating conditions. In that situation, vehicles arrive faster than they can be served, so queue lengths can theoretically grow indefinitely, which is the unstable condition.

Since arrival volumes fluctuate throughout the peak hour, queue lengths vary. The average (50th percentile) queue length represents the maximum back of queue on a typical cycle for a signalized intersection. Average queue lengths are not reported for unsignalized intersections. The 95th percentile queue, reported for both signalized and unsignalized intersections, occurs with 95th percentile traffic volumes, and its length commonly denotes the farthest extent of the vehicle queue.

## 10.2 Capacity Analyses

We performed capacity analyses for the study intersections under 2022 Existing conditions, 2029 No-Build conditions, and 2029 Build conditions during the weekday morning and weekday evening peak hours using Trafficware's Synchro 11 software. Synchro uses, in part, the traffic operational analysis methodology of the Transportation Research Board's *Highway Capacity Manual* (HCM).<sup>2</sup> We generated the results of the capacity analyses using Synchro's Percentile Delay Method for delay, v/c ratio, and queue lengths, supported by HCM 2000 methodology for unsignalized intersection analysis due to geometric incompatibility with HCM 6 methodology. The Synchro output sheets for the capacity analyses are included in Appendix D.

### 10.2.1 2022 Existing Conditions Capacity Analysis

The first analysis evaluated traffic operations with 2022 existing traffic volumes under existing geometric conditions and signal timing/phasing. We derived peak hour factors (PHFs) and heavy vehicle percentages from the TMC data. We applied both PHFs and the heavy vehicle percentages by lane group. Table 8 summarizes the capacity analysis results for the 2022 Existing conditions.

---

<sup>2</sup> *Highway Capacity Manual 2000/2010/2016 (HCM 2000/HCM 2010/HCM 6)*, Transportation Research Board, Washington, D.C., 2000-2016.

**Table 8 – Capacity Analysis Summary: 2022 Existing Conditions**

Location	Direction / Movement <sup>a</sup>	Weekday Morning Peak Hour					Weekday Evening Peak Hour				
		v/c Ratio <sup>b</sup>	Delay <sup>c</sup>	LOS	Queue <sup>d</sup>		v/c Ratio <sup>b</sup>	Delay <sup>c</sup>	LOS	Queue <sup>d</sup>	
					50th	95th				50th	95th
Alewife Brook Pkwy (Rt 16) and Broadway [signalized]	Broadway EB – LTR	0.77	62.0	E	154	166	0.80	63.1	E	182	242
	Broadway WB – LTR	1.00	90.2	F	227	#284	1.16	139.2	F	~317	#318
	Route 16 NB – LTR	1.06	80.2	F	~601	#737	0.91	48.1	D	449	471
	Route 16 SB – LTR	0.63	35.0	D	191	233	1.02	72.7	E	~448	#613
	<b>Overall</b>	<b>1.06</b>	<b>70.4</b>	<b>E</b>	-	-	<b>1.16</b>	<b>75.7</b>	<b>E</b>	-	-
Sunnyside Ave and Broadway [unsignalized]	Broadway EB – LT	0.01	0.3	A	-	1	0.01	0.3	A	-	1
	Broadway WB – TR	0.20	0.0	A	-	0	0.26	0.0	A	-	0
	Sunnyside Ave SB – LR	0.10	14.2	B	-	8	0.22	18.7	C	-	20

<sup>a</sup> Direction: NB = Northbound, SB = Southbound, EB = Eastbound, WB = Westbound;  
 Movement: L = Left-turn, T = Through movement, R = Right-turn  
<sup>b</sup> Overall v/c ratio is the maximum v/c ratio among lane groups  
<sup>c</sup> Average vehicle delay (seconds)  
<sup>d</sup> 50th and 95th percentile queue lengths (feet) based upon average vehicle length of 25 feet  
 ~ Volume exceeds capacity, queue is theoretically infinite; queue shown is maximum after two cycles  
 # 95th percentile volume exceeds capacity, queue may be longer; queue shown is maximum after two cycles

Under 2022 Existing conditions, the intersection of Alewife Brook Parkway and Broadway will operate at overall LOS E during both the weekday morning and weekday evening peak hours. Extensive queuing and high v/c ratios are calculated at most approaches to the Alewife Brook Parkway/Broadway intersection with some approaches exceeding 1.0 v/c ratio. At intersection of Sunnyside Avenue and Broadway, all approaches operate at LOS B or better during the weekday morning peak hours, and at LOS C or better during the evening peak hours.

**10.2.2 2029 No-Build Conditions Capacity Analysis**

Under future No-Build conditions, we kept lane geometry, traffic control, and signal timing parameters the same as existing. We applied the future volumes determined in Section 4.3 (Figure 3) with the same heavy vehicle percentages and PHFs as existing. Table 9 summarizes the analysis results for 2029 No-Build conditions.



**Table 9 – Capacity Analysis Summary: 2029 No-Build Conditions**

Location	Direction / Movement <sup>a</sup>	Weekday Morning Peak Hour					Weekday Evening Peak Hour				
		v/c Ratio <sup>b</sup>	Delay <sup>c</sup>	LOS	Queue <sup>d</sup>		v/c Ratio <sup>b</sup>	Delay <sup>c</sup>	LOS	Queue <sup>d</sup>	
					50th	95th				50th	95th
Alewife Brook Pkwy (Rt 16) and Broadway [signalized]	Broadway EB – LTR	0.81	64.2	E	182	191	0.85	66.4	E	214	280
	Broadway WB – LTR	1.16	139.6	F	~317	#355	1.35	213.2	F	~416	#390
	Route 16 NB – LTR	1.28	166.5	F	~820	#932	1.13	106.5	F	~665	#653
	Route 16 SB – LTR	0.84	47.7	D	254	296	1.38	212.2	F	~664	#812
	<b>Overall</b>	<b>1.28</b>	<b>123.1</b>	<b>F</b>	-	-	<b>1.38</b>	<b>154.6</b>	<b>F</b>	-	-
Sunnyside Ave and Broadway [unsignalized]	Broadway EB – LT	0.01	0.3	A	-	1	0.01	0.4	A	-	1
	Broadway WB – TR	0.23	0.0	A	-	0	0.29	0.0	A	-	0
	Sunnyside Ave SB – LR	0.14	16.2	C	-	12	0.27	22.6	C	-	27

<sup>a</sup> Direction: NB = Northbound, SB = Southbound, EB = Eastbound, WB = Westbound;  
 Movement: L = Left-turn, T = Through movement, R = Right-turn  
<sup>b</sup> Overall v/c ratio is the maximum v/c ratio among lane groups  
<sup>c</sup> Average vehicle delay (seconds)  
<sup>d</sup> 50th and 95th percentile queue lengths (feet) based upon average vehicle length of 25 feet  
 ~ Volume exceeds capacity, queue is theoretically infinite; queue shown is maximum after two cycles  
 # 95th percentile volume exceeds capacity, queue may be longer; queue shown is maximum after two cycles

Under 2029 No-Build conditions, all movements will experience an increase in v/c ratio, delay, and queue length. At the intersection of Alewife Brook Parkway and Broadway, the overall intersection will degrade from LOS E to F during both the weekday morning and evening peak hours. At the intersection of Sunnyside Avenue and Broadway, the Sunnyside Avenue southbound approach will degrade from LOS B to C during the weekday morning peak hour. All remaining approaches at the intersection will continue to operate at the same level of service as the Existing conditions during both the weekday morning and evening peak hours.

**10.2.3 2029 Build Conditions Capacity Analysis**

We performed capacity analyses for the proposed build conditions for the future development. Under these future Build conditions, we kept lane geometry, traffic control, and signal timing parameters the same as existing for all study intersections. We applied the future volumes determined in Section 8.2 (Figure 9) with the same heavy vehicle percentages and PHFs as existing. Table 10 summarizes the analysis results for the 2029 Build conditions.



**Table 10 – Capacity Analysis Summary: 2029 Build Conditions**

Location	Direction / Movement <sup>a</sup>	Weekday Morning Peak Hour					Weekday Evening Peak Hour				
		v/c Ratio <sup>b</sup>	Delay <sup>c</sup>	LOS	Queue <sup>d</sup>		v/c Ratio <sup>b</sup>	Delay <sup>c</sup>	LOS	Queue <sup>d</sup>	
					50th	95th				50th	95th
Alewife Brook Pkwy (Rt 16) and Broadway [signalized]	Broadway EB – LTR	0.82	64.7	E	186	195	0.86	66.9	E	217	283
	Broadway WB – LTR	1.17	141.4	F	~320	#355	1.36	216.4	F	~421	#393
	Route 16 NB – LTR	1.30	174.6	F	~832	#940	1.19	131.5	F	~698	#681
	Route 16 SB – LTR	0.85	48.3	D	257	297	1.39	217.8	F	~672	#816
	<b>Overall</b>	<b>1.30</b>	<b>127.3</b>	<b>F</b>	-	-	<b>1.39</b>	<b>165.8</b>	<b>F</b>	-	-
Sunnyside Ave and Broadway [unsignalized]	Broadway EB – LT	0.02	0.3	A	-	1	0.01	0.3	A	-	1
	Broadway WB – TR	0.23	0.0	A	-	0	0.30	0.0	A	-	0
	Sunnyside Ave SB – LR	0.19	17.5	C	-	17	0.33	24.3	C	-	34
Sunnyside Ave and Site Driveway [unsignalized]	Site Driveway EB – LR	0.01	8.5	A	-	1	0.01	8.4	A	-	1
	Sunnyside Ave NB – LT	0.00	2.6	A	-	0	0.01	2.1	A	-	1
	Sunnyside Ave SB – TR	0.02	0.0	A	-	0	0.01	0.0	A	-	0

<sup>a</sup> Direction: NB = Northbound, SB = Southbound, EB = Eastbound, WB = Westbound;  
 Movement: L = Left-turn, T = Through movement, R = Right-turn  
<sup>b</sup> Overall v/c ratio is the maximum v/c ratio among lane groups  
<sup>c</sup> Average vehicle delay (seconds)  
<sup>d</sup> 50th and 95th percentile queue lengths (feet) based upon average vehicle length of 25 feet  
 ~ Volume exceeds capacity, queue is theoretically infinite; queue shown is maximum after two cycles  
 # 95th percentile volume exceeds capacity, queue may be longer; queue shown is maximum after two cycles

Under 2029 Build conditions, all movements will continue to operate at No-Build conditions levels for the two existing intersections. All movements at the intersection of Sunnyside Avenue and the Site Driveway will operate at LOS A.



## 11 Conclusions and Recommendations

Nitsch Engineering has prepared this Traffic Impact Study (TIS) for the proposed 40B housing development at 10 Sunnyside Avenue in Arlington, Massachusetts.

We studied three intersections, one signalized and two unsignalized, to establish the impact the development would have on intersection traffic operations.

The crash data over the last five years available from MassDOT indicate that intersection of Alewife Brook Parkway and Broadway was found to have a motor vehicle crash rate above the MassDOT average for the District in which the Project is located (District 4). The Highway Safety Improvement Program (HSIP) database was reviewed. The intersection of Alewife Brook Parkway and Broadway is listed as one of the top 200 Crash Clusters in the most recent (2017-2019) HSIP cluster listing. The Broadway at Sunnyside Avenue intersection is not listed as a HSIP location and has a crash rate below the MassDOT average.

We collected turning movement counts at the three study intersections. For future conditions, we projected the Existing conditions traffic volumes over a seven-year period to the horizon year 2029 using an annual growth rate of 2.0% based on expected regional growth to become our future No-Build conditions volumes. We estimated the quantity of vehicle trips the proposed development would generate based on Institute of Transportation Engineers (ITE) *Trip Generation, 10<sup>th</sup> Edition* criteria.

We performed a vehicle capacity analysis to compare the weekday morning and weekday evening peak hours of the 2022 Existing conditions, 2029 No-Build conditions, and 2029 Build conditions for each of the three study intersections. Under all conditions, the intersection of Alewife Brook Parkway and Broadway will operate poorly with most of the movements operating at LOS F. However, all movements for both intersections in Build condition will continue to operate at No-Build conditions with only minor increases in delay and queuing. The intersection of Sunnyside Avenue and the Site Driveway will operate at LOS A for all movements.

As the project is not anticipated to have a significant impact to traffic operations at the study intersections, no mitigation is recommended at this time.



## APPENDIX CONTENTS

<u>Appendix</u>	<u>Description</u>
A	Traffic Count Data
B	MassDOT's 2019 Weekday Seasonal Adjustment Factors
C	Crash Rate Worksheets
D	Capacity Analysis



Appendix A: Traffic Count Data

# LENGTH DATA ANALYSIS

## Location



Broadway  
East of Sunnyside Avenue  
Latitude: 0.000000  
Longitude: 0.000000

## Analysis Time Period



Start	End
11/2/2022	11/3/2022
12:00 AM	11:59 PM

## Vehicles Analyzed



# 17,544

## Motorcycles



Motorcycles  
Volume: 416  
Pct of Total: 2.4%  
Average Speed: 15 MPH

## Passenger Cars



Passenger Cars  
Volume: 10,340  
Pct of Total: 58.9%  
Average Speed: 20 MPH

## Light Trucks and Vans



Light Trucks and Vans  
Volume: 4,349  
Pct of Total: 24.8%  
Average Speed: 20 MPH

## Single Unit Trucks



Single Unit Trucks  
Volume: 1,910  
Pct of Total: 10.9%  
Average Speed: 17 MPH

## Buses



Buses  
Volume: 283  
Pct of Total: 1.6%  
Average Speed: 18 MPH

## Multi Unit Trucks



Multi Unit Trucks  
Volume: 246  
Pct of Total: 1.4%  
Average Speed: 15 MPH

Accurate Counts  
978-664-2565

15289001

Location : Broadway  
Location : East of Sunnyside Avenue  
City/State: Arlington, MA  
Direction: WB,

11/2/2022	0 - 3	> 3 - 6	> 6 - 9	> 9 - 12	> 12 - 15	> 15 - 18	> 18 - 21	> 21 - 24	> 24 - 27	> 27 - 30	> 30 - 33	> 33 - 36	> 36 - 39	> 39	Total
Time	MPH	MPH	MPH	MPH	MPH	MPH	MPH	MPH	MPH	MPH	MPH	MPH	MPH	MPH	
12:00 AM	0	0	0	2	0	5	2	3	6	1	0	1	0	0	20
1:00	0	0	0	0	1	0	1	6	3	0	0	0	0	0	11
2:00	0	0	0	0	0	0	2	2	2	0	0	0	0	0	6
3:00	0	0	0	0	0	0	0	5	2	2	0	0	0	0	9
4:00	0	0	1	0	1	0	0	2	4	3	0	0	0	0	11
5:00	0	0	0	0	0	1	3	14	18	2	1	0	0	0	39
6:00	0	0	0	1	0	5	23	27	24	16	2	0	1	0	99
7:00	0	0	0	0	6	12	29	73	94	51	11	6	1	0	283
8:00	0	0	3	0	4	15	41	91	77	38	18	4	0	0	291
9:00	0	0	0	1	13	10	36	68	41	27	7	0	0	0	203
10:00	0	0	4	2	18	25	42	51	41	4	3	0	0	0	190
11:00	0	0	3	5	12	16	65	54	38	4	1	0	0	0	198
12:00 PM	0	0	3	5	19	47	60	77	41	9	0	1	0	0	262
1:00	0	0	0	1	2	3	29	60	63	34	8	3	0	0	203
2:00	0	0	1	0	0	10	22	91	86	36	24	3	1	0	274
3:00	0	0	2	2	1	8	24	67	102	61	12	1	0	0	280
4:00	0	0	0	1	2	10	48	56	81	61	9	1	3	0	272
5:00	0	0	1	4	7	4	51	102	133	37	31	0	1	0	371
6:00	0	0	3	1	17	10	65	105	78	27	3	1	0	1	311
7:00	0	0	0	1	2	1	23	74	72	15	3	1	0	0	192
8:00	0	0	1	0	2	1	11	45	47	20	7	0	0	0	134
9:00	0	0	0	0	2	2	15	32	27	9	9	1	0	0	97
10:00	0	0	0	1	0	2	10	25	22	3	2	1	0	0	66
11:00	0	0	0	1	3	3	7	3	10	5	3	2	0	0	37
Total	0	0	22	28	112	190	609	1133	1112	465	154	26	7	1	3859

Percentile	15th
Speed	19
Mean Speed (Average)	23.4
10 MPH Pace Speed	18-27
Number in Pace	3000
Percent in Pace	77.7%
Number > 24 MPH	1765
Percent > 24 MPH	45.7%



Accurate Counts  
978-664-2565

15289001

Location : Broadway  
Location : East of Sunnyside Avenue  
City/State: Arlington, MA  
Direction: WB,

11/3/2022	0 - 3	> 3 - 6	> 6 - 9	> 9 - 12	> 12 - 15	> 15 - 18	> 18 - 21	> 21 - 24	> 24 - 27	> 27 - 30	> 30 - 33	> 33 - 36	> 36 - 39	> 39	Total
Time	MPH	MPH	MPH	MPH	MPH	MPH	MPH	MPH	MPH	MPH	MPH	MPH	MPH	MPH	
12:00 AM	0	0	0	0	0	0	0	5	6	2	2	0	0	0	15
1:00	0	0	0	0	0	0	0	1	2	2	1	0	0	0	6
2:00	0	0	0	0	0	0	1	1	0	0	0	0	0	0	2
3:00	0	0	0	0	1	0	0	3	4	0	0	0	1	0	9
4:00	0	0	0	0	1	1	0	5	5	0	1	0	0	0	13
5:00	0	0	1	1	0	1	4	10	10	6	1	0	0	0	34
6:00	0	0	1	3	1	0	9	28	28	17	4	0	0	0	91
7:00	0	0	0	0	2	6	23	51	106	54	16	1	0	0	259
8:00	0	0	3	0	15	8	39	67	112	34	11	2	0	1	292
9:00	0	0	0	1	1	9	27	52	59	38	10	0	0	0	197
10:00	0	0	1	1	4	4	37	56	48	26	2	1	0	1	181
11:00	0	0	3	1	0	11	15	61	87	27	9	0	3	0	217
12:00 PM	0	0	0	1	1	4	16	66	75	24	12	1	0	0	200
1:00	0	0	1	1	2	3	37	63	75	38	16	2	0	0	238
2:00	0	0	0	0	4	2	24	56	96	60	7	5	1	1	256
3:00	0	0	1	4	4	5	32	76	142	41	5	0	1	0	311
4:00	0	0	0	0	1	2	33	73	93	75	14	2	0	0	293
5:00	0	0	1	1	6	10	50	123	105	53	18	0	0	1	368
6:00	0	0	1	4	20	21	86	102	65	32	6	0	0	0	337
7:00	0	0	4	3	0	8	25	67	69	19	3	1	0	1	200
8:00	0	0	0	1	3	6	13	36	50	29	6	2	0	0	146
9:00	0	0	0	1	2	3	19	25	31	11	7	0	0	0	99
10:00	0	0	0	0	1	1	7	28	24	8	6	2	2	0	79
11:00	0	0	0	0	0	0	2	5	2	1	1	1	0	0	12
Total	0	0	17	23	69	105	499	1060	1294	597	158	20	8	5	3855
			Percentile	15th	50th	85th	95th								
			Speed	20	24	28	30								
			Mean Speed (Average)	24.3											
			10 MPH Pace Speed	20-29											
			Number in Pace	3114											
			Percent in Pace	80.8%											
			Number > 24 MPH	2082											
			Percent > 24 MPH	54.0%											
Grand Total	0	0	39	51	181	295	1108	2193	2406	1062	312	46	15	6	7714
Stats			Percentile	15th	50th	85th	95th								
			Speed	11	20	26	29								
			Mean Speed (Average)	19.7											
			10 MPH Pace Speed	19-28											
			Number in Pace	6047											
			Percent in Pace	78.4%											
			Number > 24 MPH	4848											
			Percent > 24 MPH	27.8%											

Accurate Counts  
978-664-2565

Location : Broadway  
Location : East of Sunnyside Avenue  
City/State: Arlington, MA  
Direction: EB,

15289001

11/2/2022	0 - 3	> 3 - 6	> 6 - 9	> 9 - 12	> 12 - 15	> 15 - 18	> 18 - 21	> 21 - 24	> 24 - 27	> 27 - 30	> 30 - 33	> 33 - 36	> 36 - 39	> 39	Total
Time	MPH	MPH	MPH	MPH	MPH	MPH	MPH	MPH	MPH	MPH	MPH	MPH	MPH	MPH	
12:00 AM	0	0	0	2	7	0	2	5	2	1	1	0	1	1	22
1:00	0	0	0	0	0	0	1	0	3	1	0	0	0	0	5
2:00	0	0	0	0	0	2	3	0	2	2	0	0	0	0	9
3:00	0	0	0	0	2	0	1	1	3	1	1	0	0	0	9
4:00	0	0	0	1	0	0	3	2	6	3	2	0	0	1	18
5:00	0	0	1	1	3	6	9	10	7	2	4	1	1	1	46
6:00	0	0	26	20	23	20	38	32	23	10	4	1	0	2	199
7:00	0	0	67	65	77	45	43	18	19	4	5	0	0	2	345
8:00	0	0	89	87	90	33	20	3	3	1	1	0	0	1	328
9:00	0	0	54	54	81	48	52	32	19	6	1	2	0	2	351
10:00	0	0	21	23	59	38	33	35	16	9	3	1	0	0	238
11:00	0	0	38	45	71	55	55	25	9	5	0	0	0	0	303
12:00 PM	0	0	40	39	57	38	46	25	12	2	2	1	0	0	262
1:00	0	0	46	36	48	35	45	31	17	12	1	1	0	1	273
2:00	0	0	42	41	64	43	43	36	15	8	6	0	0	3	301
3:00	0	0	57	44	60	73	54	31	21	10	2	0	0	1	353
4:00	0	0	78	67	80	63	54	33	28	6	3	1	0	1	414
5:00	0	0	76	58	83	48	78	32	12	7	4	1	0	2	401
6:00	0	0	76	74	99	78	46	18	6	0	0	0	0	0	397
7:00	0	0	35	29	56	44	48	27	20	7	3	1	0	1	271
8:00	0	0	17	12	23	30	38	25	17	10	1	0	0	2	175
9:00	0	0	2	13	24	17	32	11	11	10	3	1	1	0	125
10:00	0	0	1	6	8	10	14	11	7	5	0	0	0	0	62
11:00	0	0	0	3	4	6	8	10	7	2	1	0	0	0	41
<b>Total</b>	<b>0</b>	<b>0</b>	<b>766</b>	<b>720</b>	<b>1019</b>	<b>732</b>	<b>766</b>	<b>453</b>	<b>285</b>	<b>124</b>	<b>48</b>	<b>11</b>	<b>3</b>	<b>21</b>	<b>4948</b>

Percentile 15th 50th 85th 95th  
Speed 9 15 22 26  
Mean Speed (Average) 16.3  
10 MPH Pace Speed 11-20  
Number in Pace 2755  
Percent in Pace 55.7%  
Number > 24 MPH 492  
Percent > 24 MPH 9.9%

Accurate Counts  
978-664-2565

Location : Broadway  
Location : East of Sunnyside Avenue  
City/State: Arlington, MA  
Direction: EB,

15289001

11/3/2022	0 - 3	> 3 - 6	> 6 - 9	> 9 - 12	> 12 - 15	> 15 - 18	> 18 - 21	> 21 - 24	> 24 - 27	> 27 - 30	> 30 - 33	> 33 - 36	> 36 - 39	> 39	Total
Time	MPH	MPH	MPH	MPH	MPH	MPH	MPH	MPH	MPH	MPH	MPH	MPH	MPH	MPH	
12:00 AM	0	0	0	1	2	0	4	6	4	2	0	1	1	0	21
1:00	0	0	0	1	0	0	1	0	2	1	0	0	0	0	5
2:00	0	0	0	0	0	1	0	2	0	1	0	0	0	0	4
3:00	0	0	0	0	0	1	2	1	2	2	0	0	0	0	8
4:00	0	0	0	0	0	1	2	5	3	2	1	0	0	1	15
5:00	0	0	0	1	7	5	6	11	9	5	1	3	1	0	49
6:00	0	0	17	19	25	21	39	19	12	6	7	3	2	2	172
7:00	0	0	60	49	67	65	55	32	24	8	2	1	0	2	365
8:00	0	0	88	75	88	43	39	9	7	0	0	0	0	5	354
9:00	0	0	77	51	68	49	40	23	12	4	2	0	0	2	328
10:00	0	0	26	26	41	44	43	27	19	6	5	2	0	1	240
11:00	0	0	35	18	40	45	47	29	29	10	2	1	1	1	258
12:00 PM	0	0	32	38	50	34	38	27	25	7	9	2	1	0	263
1:00	0	0	43	37	51	36	53	25	18	12	7	2	0	3	287
2:00	0	0	40	28	45	49	53	31	20	10	0	4	0	1	281
3:00	0	0	47	42	86	68	52	29	21	10	5	0	0	0	360
4:00	0	0	65	49	81	71	74	23	15	6	0	0	0	0	384
5:00	0	0	89	80	86	53	45	18	16	4	1	0	0	2	394
6:00	0	0	74	67	82	54	53	22	5	2	2	0	0	0	361
7:00	0	0	33	25	61	33	49	29	18	3	2	0	1	0	254
8:00	0	0	11	22	39	30	28	23	14	4	0	1	0	0	172
9:00	0	0	3	15	27	15	32	18	9	5	1	1	0	1	127
10:00	0	0	2	3	24	12	17	13	6	7	1	1	0	1	87
11:00	0	0	0	1	5	2	4	2	0	2	0	0	1	0	17
<b>Total</b>	<b>0</b>	<b>0</b>	<b>742</b>	<b>648</b>	<b>975</b>	<b>732</b>	<b>776</b>	<b>424</b>	<b>290</b>	<b>119</b>	<b>48</b>	<b>22</b>	<b>8</b>	<b>22</b>	<b>4806</b>
				Percentile	15th	50th	85th	95th							
				Speed	9	15	22	26							
				Mean Speed (Average)	16.5										
				10 MPH Pace Speed	11-20										
				Number in Pace	2695										
				Percent in Pace	56.1%										
				Number > 24 MPH	509										
				Percent > 24 MPH	10.6%										
<b>Grand Total</b>	<b>0</b>	<b>0</b>	<b>1508</b>	<b>1368</b>	<b>1994</b>	<b>1464</b>	<b>1542</b>	<b>877</b>	<b>575</b>	<b>243</b>	<b>96</b>	<b>33</b>	<b>11</b>	<b>43</b>	<b>9754</b>
<b>Stats</b>				Percentile	15th	50th	85th	95th							
				Speed	9	15	22	26							
				Mean Speed (Average)	16.4										
				10 MPH Pace Speed	11-20										
				Number in Pace	5450										
				Percent in Pace	55.9%										
				Number > 24 MPH	1001										
				Percent > 24 MPH	10.3%										

Accurate Counts  
978-664-2565

15289001

Location : Broadway  
Location : East of Sunnyside Avenue  
City/State: Arlington, MA  
Direction: Combined

11/2/2022	0 - 3	> 3 - 6	> 6 - 9	> 9 - 12	> 12 - 15	> 15 - 18	> 18 - 21	> 21 - 24	> 24 - 27	> 27 - 30	> 30 - 33	> 33 - 36	> 36 - 39	> 39	Total
Time	MPH	MPH	MPH	MPH	MPH	MPH	MPH	MPH	MPH	MPH	MPH	MPH	MPH	MPH	
12:00 AM	0	0	0	4	7	5	4	8	8	2	1	1	1	1	42
1:00	0	0	0	0	1	0	2	6	6	1	0	0	0	0	16
2:00	0	0	0	0	0	2	5	2	4	2	0	0	0	0	15
3:00	0	0	0	0	2	0	1	6	5	3	1	0	0	0	18
4:00	0	0	1	1	1	0	3	4	10	6	2	0	0	1	29
5:00	0	0	1	1	3	7	12	24	25	4	5	1	1	1	85
6:00	0	0	26	21	23	25	61	59	47	26	6	1	1	2	298
7:00	0	0	67	65	83	57	72	91	113	55	16	6	1	2	628
8:00	0	0	92	87	94	48	61	94	80	39	19	4	0	1	619
9:00	0	0	54	55	94	58	88	100	60	33	8	2	0	2	554
10:00	0	0	25	25	77	63	75	86	57	13	6	1	0	0	428
11:00	0	0	41	50	83	71	120	79	47	9	1	0	0	0	501
12:00 PM	0	0	43	44	76	85	106	102	53	11	2	2	0	0	524
1:00	0	0	46	37	50	38	74	91	80	46	9	4	0	1	476
2:00	0	0	43	41	64	53	65	127	101	44	30	3	1	3	575
3:00	0	0	59	46	61	81	78	98	123	71	14	1	0	1	633
4:00	0	0	78	68	82	73	102	89	109	67	12	2	3	1	686
5:00	0	0	77	62	90	52	129	134	145	44	35	1	1	2	772
6:00	0	0	79	75	116	88	111	123	84	27	3	1	0	1	708
7:00	0	0	35	30	58	45	71	101	92	22	6	2	0	1	463
8:00	0	0	18	12	25	31	49	70	64	30	8	0	0	2	309
9:00	0	0	2	13	26	19	47	43	38	19	12	2	1	0	222
10:00	0	0	1	7	8	12	24	36	29	8	2	1	0	0	128
11:00	0	0	0	4	7	9	15	13	17	7	4	2	0	0	78
Total	0	0	788	748	1131	922	1375	1586	1397	589	202	37	10	22	8807

Percentile	15th	50th	85th	95th
Speed	11	20	25	29
Mean Speed (Average)	19.4			
10 MPH Pace Speed	17-26			
Number in Pace	4650			
Percent in Pace	52.8%			
Number > 24 MPH	2257			
Percent > 24 MPH	25.6%			

Accurate Counts  
978-664-2565

Location : Broadway  
Location : East of Sunnyside Avenue  
City/State: Arlington, MA  
Direction: Combined

15289001

11/3/2022	0 - 3	> 3 - 6	> 6 - 9	> 9 - 12	> 12 - 15	> 15 - 18	> 18 - 21	> 21 - 24	> 24 - 27	> 27 - 30	> 30 - 33	> 33 - 36	> 36 - 39	> 39	Total
Time	MPH	MPH	MPH	MPH	MPH	MPH	MPH	MPH	MPH	MPH	MPH	MPH	MPH	MPH	
12:00 AM	0	0	0	1	2	0	4	11	10	4	2	1	1	0	36
1:00	0	0	0	1	0	0	1	1	4	3	1	0	0	0	11
2:00	0	0	0	0	0	1	1	3	0	1	0	0	0	0	6
3:00	0	0	0	0	1	1	2	4	6	2	0	0	1	0	17
4:00	0	0	0	0	1	2	2	10	8	2	2	0	0	1	28
5:00	0	0	1	2	7	6	10	21	19	11	2	3	1	0	83
6:00	0	0	18	22	26	21	48	47	40	23	11	3	2	2	263
7:00	0	0	60	49	69	71	78	83	130	62	18	2	0	2	624
8:00	0	0	91	75	103	51	78	76	119	34	11	2	0	6	646
9:00	0	0	77	52	69	58	67	75	71	42	12	0	0	2	525
10:00	0	0	27	27	45	48	80	83	67	32	7	3	0	2	421
11:00	0	0	38	19	40	56	62	90	116	37	11	1	4	1	475
12:00 PM	0	0	32	39	51	38	54	93	100	31	21	3	1	0	463
1:00	0	0	44	38	53	39	90	88	93	50	23	4	0	3	525
2:00	0	0	40	28	49	51	77	87	116	70	7	9	1	2	537
3:00	0	0	48	46	90	73	84	105	163	51	10	0	1	0	671
4:00	0	0	65	49	82	73	107	96	108	81	14	2	0	0	677
5:00	0	0	90	81	92	63	95	141	121	57	19	0	0	3	762
6:00	0	0	75	71	102	75	139	124	70	34	8	0	0	0	698
7:00	0	0	37	28	61	41	74	96	87	22	5	1	1	1	454
8:00	0	0	11	23	42	36	41	59	64	33	6	3	0	0	318
9:00	0	0	3	16	29	18	51	43	40	16	8	1	0	1	226
10:00	0	0	2	3	25	13	24	41	30	15	7	3	2	1	166
11:00	0	0	0	1	5	2	6	7	2	3	1	1	1	0	29
Total	0	0	759	671	1044	837	1275	1484	1584	716	206	42	16	27	8661
			Percentile	15th	50th	85th	95th								
			Speed	12	20	26	29								
			Mean Speed (Average)	19.9											
			10 MPH Pace Speed	17-26											
			Number in Pace	4597											
			Percent in Pace	53.1%											
			Number > 24 MPH	2591											
			Percent > 24 MPH	29.9%											
Grand Total	0	0	1547	1419	2175	1759	2650	3070	2981	1305	408	79	26	49	17468
Stats			Percentile	15th	50th	85th	95th								
			Speed	11	20	26	29								
			Mean Speed (Average)	19.7											
			10 MPH Pace Speed	17-26											
			Number in Pace	9247											
			Percent in Pace	52.9%											
			Number > 24 MPH	4848											
			Percent > 24 MPH	27.8%											

Accurate Counts  
978-664-2565

15289001

Location : Broadway  
Location : East of Sunnyside Avenue  
City/State: Arlington, MA

11/2/2022 Time	WB,		Hour Totals		EB,		Hour Totals		Combined Totals	
	Morning	Afternoon	Morning	Afternoon	Morning	Afternoon	Morning	Afternoon	Morning	Afternoon
12:00	7	71			3	64				
12:15	5	65			5	64				
12:30	5	66			8	70				
12:45	3	60	20	262	6	64	22	262	42	524
1:00	5	44			3	68				
1:15	4	56			0	78				
1:30	1	40			2	69				
1:45	1	63	11	203	0	58	5	273	16	476
2:00	0	70			5	69				
2:15	3	53			1	64				
2:30	1	71			0	79				
2:45	2	80	6	274	3	89	9	301	15	575
3:00	3	71			1	85				
3:15	3	60			2	97				
3:30	2	79			5	95				
3:45	1	70	9	280	1	76	9	353	18	633
4:00	2	63			0	104				
4:15	3	71			6	106				
4:30	3	73			9	104				
4:45	3	65	11	272	3	100	18	414	29	686
5:00	1	99			5	98				
5:15	6	102			10	105				
5:30	19	91			13	112				
5:45	13	79	39	371	18	86	46	401	85	772
6:00	13	83			37	111				
6:15	13	73			39	102				
6:30	36	81			53	104				
6:45	37	74	99	311	70	80	199	397	298	708
7:00	36	55			77	78				
7:15	56	56			83	78				
7:30	87	47			121	70				
7:45	104	34	283	192	64	45	345	271	628	463
8:00	76	38			84	47				
8:15	64	33			72	35				
8:30	93	33			96	44				
8:45	58	30	291	134	76	49	328	175	619	309
9:00	56	32			90	34				
9:15	55	29			95	32				
9:30	45	23			99	37				
9:45	47	13	203	97	67	22	351	125	554	222
10:00	32	21			59	22				
10:15	56	16			49	16				
10:30	42	16			69	13				
10:45	60	13	190	66	61	11	238	62	428	128
11:00	52	13			78	12				
11:15	50	11			71	15				
11:30	53	2			66	5				
11:45	43	11	198	37	88	9	303	41	501	78
Total	1360	2499			1873	3075			3233	5574
Percent	35.2%	64.8%			37.9%	62.1%			36.7%	63.3%

Accurate Counts  
978-664-2565

Location : Broadway  
Location : East of Sunnyside Avenue  
City/State: Arlington, MA

15289001

11/3/2022 Time	WB,		Hour Totals		EB,		Hour Totals		Combined Totals	
	Morning	Afternoon	Morning	Afternoon	Morning	Afternoon	Morning	Afternoon	Morning	Afternoon
12:00	6	56			5	44				
12:15	5	61			4	70				
12:30	1	35			7	86				
12:45	3	48	15	200	5	63	21	263	36	463
1:00	0	52			2	74				
1:15	3	61			2	76				
1:30	2	64			1	73				
1:45	1	61	6	238	0	64	5	287	11	525
2:00	0	54			1	56				
2:15	1	69			2	70				
2:30	0	70			1	83				
2:45	1	63	2	256	0	72	4	281	6	537
3:00	3	62			1	75				
3:15	3	87			2	100				
3:30	1	73			1	85				
3:45	2	89	9	311	4	100	8	360	17	671
4:00	1	69			2	97				
4:15	2	61			3	93				
4:30	4	83			2	98				
4:45	6	80	13	293	8	96	15	384	28	677
5:00	6	87			7	110				
5:15	5	87			10	83				
5:30	12	101			10	101				
5:45	11	93	34	368	22	100	49	394	83	762
6:00	14	83			34	84				
6:15	11	92			36	100				
6:30	27	99			46	83				
6:45	39	63	91	337	56	94	172	361	263	698
7:00	38	60			65	71				
7:15	53	55			99	58				
7:30	85	45			116	56				
7:45	83	40	259	200	85	69	365	254	624	454
8:00	77	42			91	41				
8:15	71	41			72	51				
8:30	80	39			92	38				
8:45	64	24	292	146	99	42	354	172	646	318
9:00	63	24			85	28				
9:15	51	30			77	40				
9:30	39	16			91	30				
9:45	44	29	197	99	75	29	328	127	525	226
10:00	43	16			63	24				
10:15	41	21			52	21				
10:30	43	24			57	24				
10:45	54	18	181	79	68	18	240	87	421	166
11:00	45	12			66	17				
11:15	57	*			65	*				
11:30	50	*			56	*				
11:45	65	*	217	12	71	*	258	17	475	29
Total	1316	2539			1819	2987			3135	5526
Percent	34.1%	65.9%			37.8%	62.2%			36.2%	63.8%
Grand Total	2676	5038			3692	6062			6368	11100
Percent	34.7%	65.3%			37.9%	62.1%			36.5%	63.5%

ADT

ADT: 8,772

AADT: 8,772



Accurate Counts  
978-664-2565

15289001

Location : Broadway  
Location : East of Sunnyside Avenue  
City/State: Arlington, MA

10/31/2022 Time	Monday		Tuesday		Wednesday		Thursday		Friday		Saturday		Sunday		Week Average	
	WB,	EB,	WB,	EB,	WB,	EB,	WB,	EB,	WB,	EB,	WB,	EB,	WB,	EB,	WB,	EB,
12:00 AM	*	*	*	*	20	22	15	21	*	*	*	*	*	*	18	22
1:00	*	*	*	*	11	5	6	5	*	*	*	*	*	*	8	5
2:00	*	*	*	*	6	9	2	4	*	*	*	*	*	*	4	6
3:00	*	*	*	*	9	9	9	8	*	*	*	*	*	*	9	8
4:00	*	*	*	*	11	18	13	15	*	*	*	*	*	*	12	16
5:00	*	*	*	*	39	46	34	49	*	*	*	*	*	*	36	48
6:00	*	*	*	*	99	199	91	172	*	*	*	*	*	*	95	186
7:00	*	*	*	*	283	345	259	365	*	*	*	*	*	*	271	355
8:00	*	*	*	*	291	328	292	354	*	*	*	*	*	*	292	341
9:00	*	*	*	*	203	351	197	328	*	*	*	*	*	*	200	340
10:00	*	*	*	*	190	238	181	240	*	*	*	*	*	*	186	239
11:00	*	*	*	*	198	303	217	258	*	*	*	*	*	*	208	280
12:00 PM	*	*	*	*	262	262	200	263	*	*	*	*	*	*	231	262
1:00	*	*	*	*	203	273	238	287	*	*	*	*	*	*	220	280
2:00	*	*	*	*	274	301	256	281	*	*	*	*	*	*	265	291
3:00	*	*	*	*	280	353	311	360	*	*	*	*	*	*	296	356
4:00	*	*	*	*	272	414	293	384	*	*	*	*	*	*	282	399
5:00	*	*	*	*	371	401	368	394	*	*	*	*	*	*	370	398
6:00	*	*	*	*	311	397	337	361	*	*	*	*	*	*	324	379
7:00	*	*	*	*	192	271	200	254	*	*	*	*	*	*	196	262
8:00	*	*	*	*	134	175	146	172	*	*	*	*	*	*	140	174
9:00	*	*	*	*	97	125	99	127	*	*	*	*	*	*	98	126
10:00	*	*	*	*	66	62	79	87	*	*	*	*	*	*	72	74
11:00	*	*	*	*	37	41	12	17	*	*	*	*	*	*	24	29
Total	0	0	0	0	3859	4948	3855	4806	0	0	0	0	0	0	3857	4876
Day	0		0		8807		8661		0		0		0		8733	
AM Peak Volume					8:00 291	9:00 351	8:00 292	7:00 365							8:00 292	7:00 355
PM Peak Volume					5:00 371	4:00 414	5:00 368	5:00 394							5:00 370	4:00 399
Comb Total ADT	0 ADT: 8,772		0 AADT: 8,772		8807		8661		0		0		0		8733	

**Accurate Counts**  
978-664-2565

N/S Street : Alewife Brook Parkway  
E/W Street : Broadway  
City/State : Arlington, MA  
Weather : Clear

File Name : 15289001  
Site Code : 15289001  
Start Date : 11/3/2022  
Page No : 1

Groups Printed- Cars - Trucks

Start Time	Alewife Brook Pkwy From North			Broadway From East			Alewife Brook Pkwy From South			Broadway From West			Int. Total
	Left	Thru	Right	Left	Thru	Right	Left	Thru	Right	Left	Thru	Right	
07:00 AM	4	112	22	25	28	15	3	283	10	24	22	0	548
07:15 AM	1	84	22	33	54	10	3	247	15	34	36	2	541
07:30 AM	6	73	16	46	69	12	5	223	28	24	49	5	556
07:45 AM	6	90	14	28	73	11	9	221	24	30	54	4	564
<b>Total</b>	<b>17</b>	<b>359</b>	<b>74</b>	<b>132</b>	<b>224</b>	<b>48</b>	<b>20</b>	<b>974</b>	<b>77</b>	<b>112</b>	<b>161</b>	<b>11</b>	<b>2209</b>
08:00 AM	6	88	28	34	65	5	12	201	12	21	50	8	530
08:15 AM	10	101	22	48	53	14	5	200	18	33	39	3	546
08:30 AM	4	78	21	45	63	10	7	177	27	21	51	3	507
08:45 AM	3	108	31	39	62	5	8	178	16	24	35	5	514
<b>Total</b>	<b>23</b>	<b>375</b>	<b>102</b>	<b>166</b>	<b>243</b>	<b>34</b>	<b>32</b>	<b>756</b>	<b>73</b>	<b>99</b>	<b>175</b>	<b>19</b>	<b>2097</b>
<b>Grand Total</b>	<b>40</b>	<b>734</b>	<b>176</b>	<b>298</b>	<b>467</b>	<b>82</b>	<b>52</b>	<b>1730</b>	<b>150</b>	<b>211</b>	<b>336</b>	<b>30</b>	<b>4306</b>
Apprch %	4.2	77.3	18.5	35.2	55.1	9.7	2.7	89.5	7.8	36.6	58.2	5.2	
Total %	0.9	17	4.1	6.9	10.8	1.9	1.2	40.2	3.5	4.9	7.8	0.7	
Cars	39	731	170	297	453	82	52	1729	150	208	319	29	4259
% Cars	97.5	99.6	96.6	99.7	97	100	100	99.9	100	98.6	94.9	96.7	98.9
Trucks	1	3	6	1	14	0	0	1	0	3	17	1	47
% Trucks	2.5	0.4	3.4	0.3	3	0	0	0.1	0	1.4	5.1	3.3	1.1

Start Time	Alewife Brook Pkwy From North				Broadway From East				Alewife Brook Pkwy From South				Broadway From West				Int. Total
	Left	Thru	Right	App. Total	Left	Thru	Right	App. Total	Left	Thru	Right	App. Total	Left	Thru	Right	App. Total	
Peak Hour Analysis From 07:00 AM to 08:45 AM - Peak 1 of 1																	
Peak Hour for Entire Intersection Begins at 07:00 AM																	
07:00 AM	4	<b>112</b>	<b>22</b>	<b>138</b>	25	28	<b>15</b>	68	3	<b>283</b>	10	<b>296</b>	24	22	0	46	548
07:15 AM	1	84	22	107	33	54	10	97	3	247	15	265	<b>34</b>	36	2	72	541
07:30 AM	<b>6</b>	73	16	95	<b>46</b>	69	12	<b>127</b>	5	223	<b>28</b>	256	24	49	<b>5</b>	78	556
07:45 AM	6	90	14	110	28	<b>73</b>	11	112	<b>9</b>	221	24	254	30	<b>54</b>	4	<b>88</b>	<b>564</b>
Total Volume	17	359	74	450	132	224	48	404	20	974	77	1071	112	161	11	284	2209
% App. Total	3.8	79.8	16.4		32.7	55.4	11.9		1.9	90.9	7.2		39.4	56.7	3.9		
PHF	.708	.801	.841	.815	.717	.767	.800	.795	.556	.860	.688	.905	.824	.745	.550	.807	.979
Cars	16	359	72	447	132	219	48	399	20	974	77	1071	109	152	10	271	2188
% Cars	94.1	100	97.3	99.3	100	97.8	100	98.8	100	100	100	100	97.3	94.4	90.9	95.4	99.0
Trucks	1	0	2	3	0	5	0	5	0	0	0	0	3	9	1	13	21
% Trucks	5.9	0	2.7	0.7	0	2.2	0	1.2	0	0	0	0	2.7	5.6	9.1	4.6	1.0

N/S Street : Alewife Brook Parkway  
E/W Street : Broadway  
City/State : Arlington, MA  
Weather : Clear

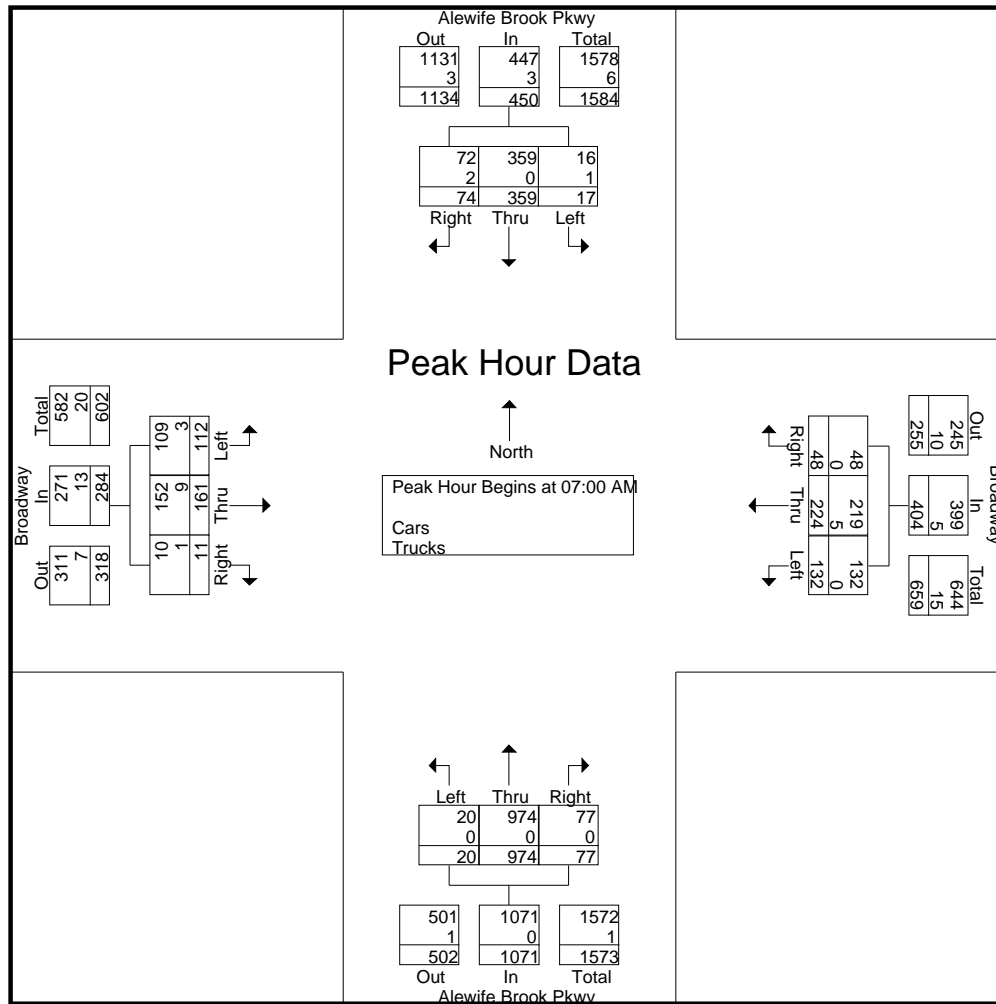

Peak Hour Analysis From 07:00 AM to 08:45 AM - Peak 1 of 1  
Peak Hour for Each Approach Begins at:

	08:00 AM				07:30 AM				07:00 AM				07:30 AM			
+0 mins.	6	88	28	122	46	69	12	<b>127</b>	3	<b>283</b>	10	<b>296</b>	24	49	5	78
+15 mins.	<b>10</b>	101	22	133	28	<b>73</b>	11	112	3	247	15	265	30	<b>54</b>	4	<b>88</b>
+30 mins.	4	78	21	103	34	65	5	104	5	223	<b>28</b>	256	21	50	<b>8</b>	79
+45 mins.	3	<b>108</b>	<b>31</b>	<b>142</b>	<b>48</b>	53	<b>14</b>	115	<b>9</b>	221	24	254	<b>33</b>	39	3	75
Total Volume	23	375	102	500	156	260	42	458	20	974	77	1071	108	192	20	320
% App. Total	4.6	75	20.4		34.1	56.8	9.2		1.9	90.9	7.2		33.8	60	6.2	
PHF	.575	.868	.823	.880	.813	.890	.750	.902	.556	.860	.688	.905	.818	.889	.625	.909
Cars	23	372	98	493	156	253	42	451	20	974	77	1071	108	183	19	310
% Cars	100	99.2	96.1	98.6	100	97.3	100	98.5	100	100	100	100	100	95.3	95	96.9
Trucks	0	3	4	7	0	7	0	7	0	0	0	0	0	9	1	10
% Trucks	0	0.8	3.9	1.4	0	2.7	0	1.5	0	0	0	0	0	4.7	5	3.1

N/S Street : Alewife Brook Parkway  
E/W Street : Broadway  
City/State : Arlington, MA  
Weather : Clear

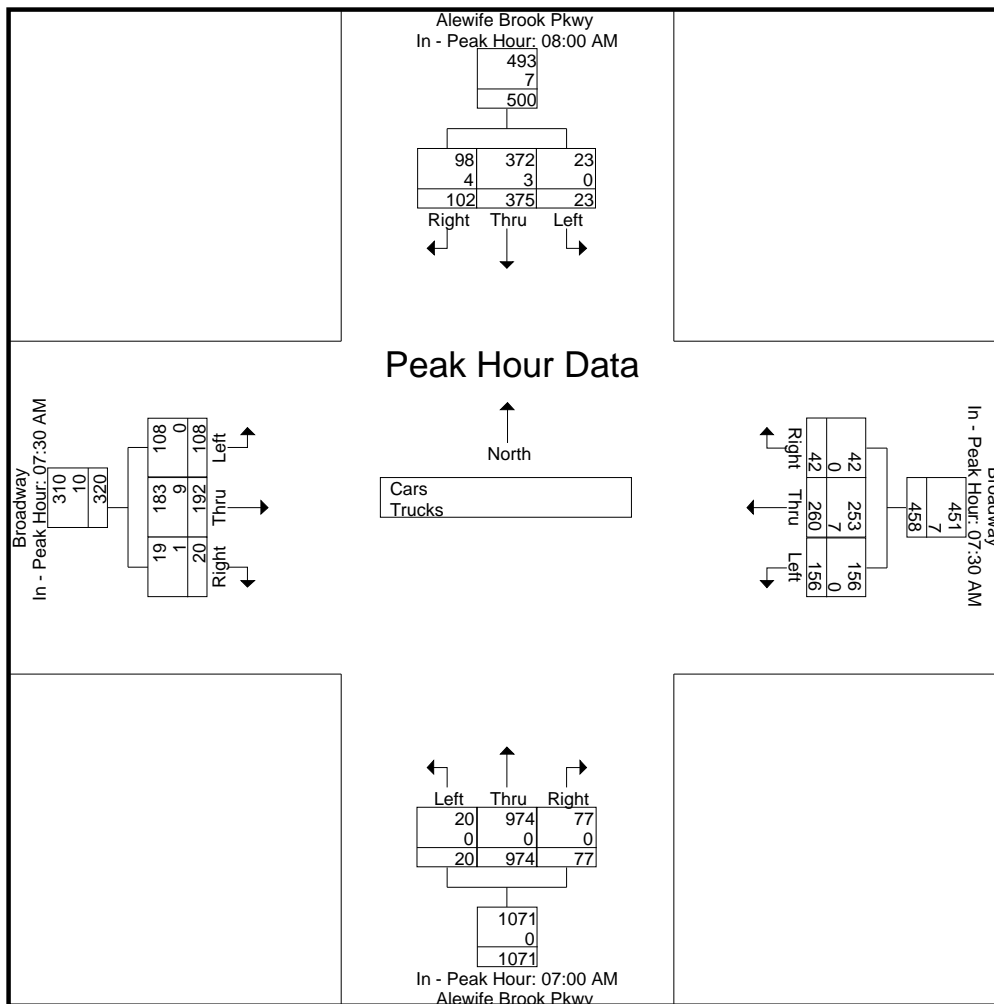



# Accurate Counts

978-664-2565

N/S Street : Alewife Brook Parkway  
 E/W Street : Broadway  
 City/State : Arlington, MA  
 Weather : Clear

File Name : 15289001  
 Site Code : 15289001  
 Start Date : 11/3/2022  
 Page No : 4

## Groups Printed- Cars

Start Time	Alewife Brook Pkwy From North			Broadway From East			Alewife Brook Pkwy From South			Broadway From West			Int. Total
	Left	Thru	Right	Left	Thru	Right	Left	Thru	Right	Left	Thru	Right	
07:00 AM	3	112	20	25	27	15	3	283	10	23	22	0	543
07:15 AM	1	84	22	33	52	10	3	247	15	32	32	2	533
07:30 AM	6	73	16	46	69	12	5	223	28	24	47	4	553
07:45 AM	6	90	14	28	71	11	9	221	24	30	51	4	559
Total	16	359	72	132	219	48	20	974	77	109	152	10	2188
08:00 AM	6	88	27	34	63	5	12	201	12	21	48	8	525
08:15 AM	10	100	20	48	50	14	5	199	18	33	37	3	537
08:30 AM	4	77	21	45	59	10	7	177	27	21	49	3	500
08:45 AM	3	107	30	38	62	5	8	178	16	24	33	5	509
Total	23	372	98	165	234	34	32	755	73	99	167	19	2071
Grand Total	39	731	170	297	453	82	52	1729	150	208	319	29	4259
Apprch %	4.1	77.8	18.1	35.7	54.4	9.9	2.7	89.5	7.8	37.4	57.4	5.2	
Total %	0.9	17.2	4	7	10.6	1.9	1.2	40.6	3.5	4.9	7.5	0.7	

Start Time	Alewife Brook Pkwy From North				Broadway From East				Alewife Brook Pkwy From South				Broadway From West				Int. Total
	Left	Thru	Right	App. Total	Left	Thru	Right	App. Total	Left	Thru	Right	App. Total	Left	Thru	Right	App. Total	
Peak Hour Analysis From 07:00 AM to 08:45 AM - Peak 1 of 1																	
Peak Hour for Entire Intersection Begins at 07:00 AM																	
07:00 AM	3	<b>112</b>	20	<b>135</b>	25	27	<b>15</b>	67	3	<b>283</b>	10	<b>296</b>	23	22	0	45	543
07:15 AM	1	84	<b>22</b>	107	33	52	10	95	3	247	15	265	<b>32</b>	32	2	66	533
07:30 AM	<b>6</b>	73	16	95	<b>46</b>	69	12	<b>127</b>	5	223	<b>28</b>	256	24	47	<b>4</b>	75	553
07:45 AM	6	90	14	110	28	<b>71</b>	11	110	<b>9</b>	221	24	254	30	<b>51</b>	4	<b>85</b>	<b>559</b>
Total Volume	16	359	72	447	132	219	48	399	20	974	77	1071	109	152	10	271	2188
% App. Total	3.6	80.3	16.1		33.1	54.9	12		1.9	90.9	7.2		40.2	56.1	3.7		
PHF	.667	.801	.818	.828	.717	.771	.800	.785	.556	.860	.688	.905	.852	.745	.625	.797	.979

N/S Street : Alewife Brook Parkway  
E/W Street : Broadway  
City/State : Arlington, MA  
Weather : Clear

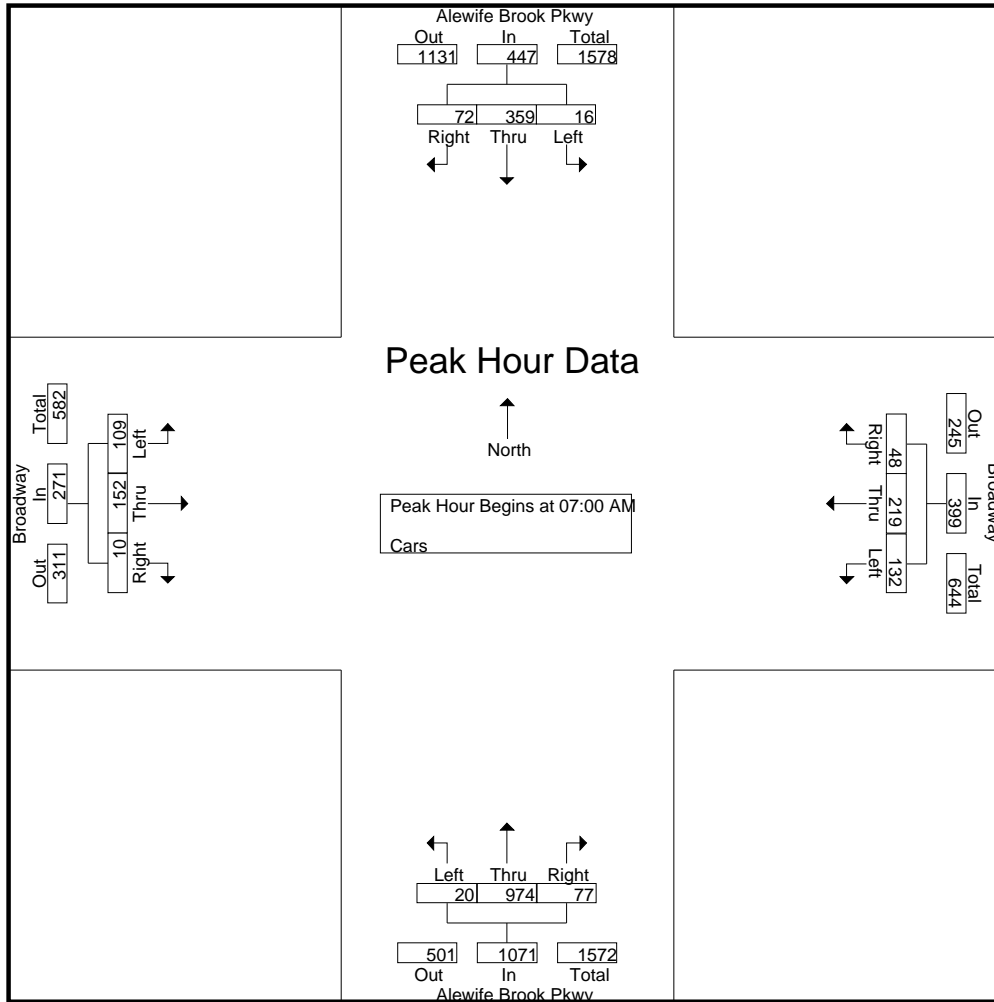

Peak Hour Analysis From 07:00 AM to 08:45 AM - Peak 1 of 1  
Peak Hour for Each Approach Begins at:

	08:00 AM				07:30 AM				07:00 AM				07:30 AM			
+0 mins.	6	88	27	121	46	69	12	<b>127</b>	3	<b>283</b>	10	<b>296</b>	24	47	4	75
+15 mins.	<b>10</b>	100	20	130	28	<b>71</b>	11	110	3	247	15	265	30	<b>51</b>	4	<b>85</b>
+30 mins.	4	77	21	102	34	63	5	102	5	223	<b>28</b>	256	21	48	<b>8</b>	77
+45 mins.	3	<b>107</b>	<b>30</b>	<b>140</b>	<b>48</b>	50	<b>14</b>	112	<b>9</b>	221	24	254	<b>33</b>	37	3	73
Total Volume	23	372	98	493	156	253	42	451	20	974	77	1071	108	183	19	310
% App. Total	4.7	75.5	19.9		34.6	56.1	9.3		1.9	90.9	7.2		34.8	59	6.1	
PHF	.575	.869	.817	.880	.813	.891	.750	.888	.556	.860	.688	.905	.818	.897	.594	.912

N/S Street : Alewife Brook Parkway  
E/W Street : Broadway  
City/State : Arlington, MA  
Weather : Clear

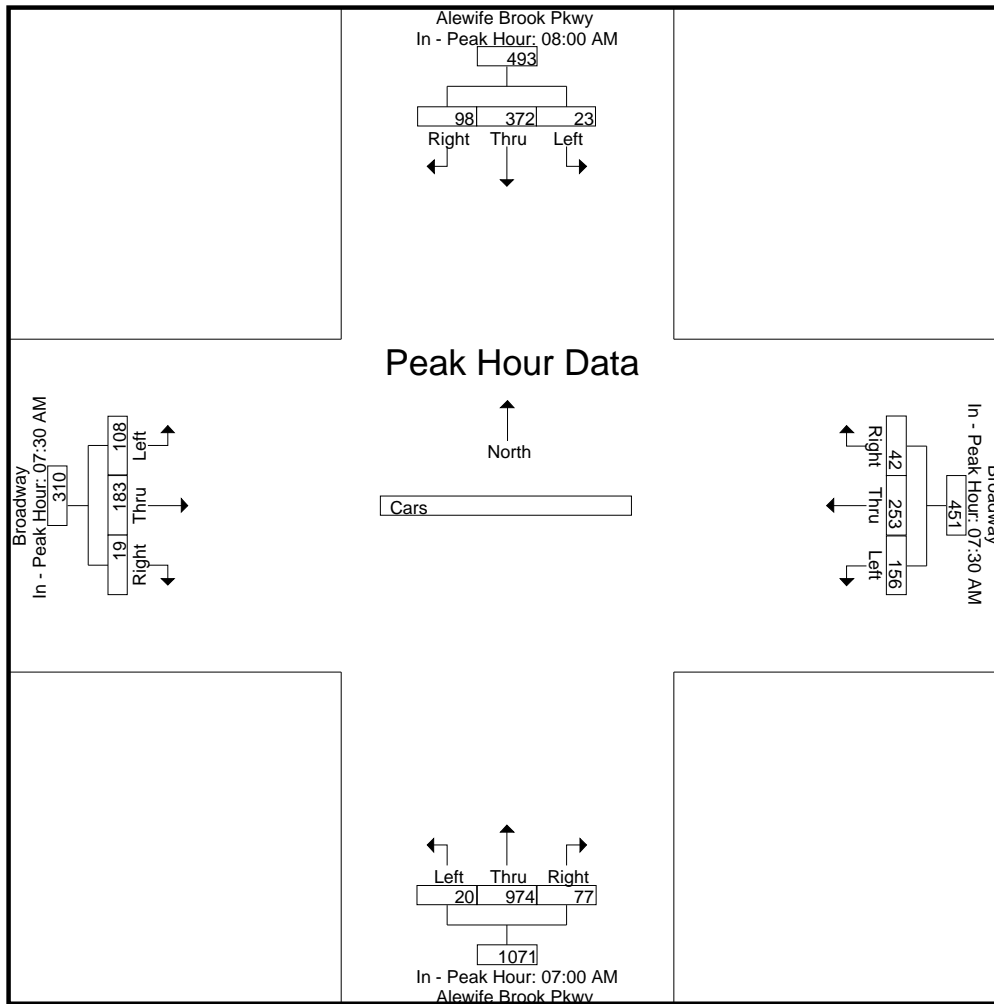

**Accurate Counts**  
978-664-2565

N/S Street : Alewife Brook Parkway  
E/W Street : Broadway  
City/State : Arlington, MA  
Weather : Clear

File Name : 15289001  
Site Code : 15289001  
Start Date : 11/3/2022  
Page No : 7

Groups Printed- Trucks

Start Time	Alewife Brook Pkwy From North			Broadway From East			Alewife Brook Pkwy From South			Broadway From West			Int. Total
	Left	Thru	Right	Left	Thru	Right	Left	Thru	Right	Left	Thru	Right	
07:00 AM	1	0	2	0	1	0	0	0	0	1	0	0	5
07:15 AM	0	0	0	0	2	0	0	0	0	2	4	0	8
07:30 AM	0	0	0	0	0	0	0	0	0	0	2	1	3
07:45 AM	0	0	0	0	2	0	0	0	0	0	3	0	5
<b>Total</b>	<b>1</b>	<b>0</b>	<b>2</b>	<b>0</b>	<b>5</b>	<b>0</b>	<b>0</b>	<b>0</b>	<b>0</b>	<b>3</b>	<b>9</b>	<b>1</b>	<b>21</b>
08:00 AM	0	0	1	0	2	0	0	0	0	0	2	0	5
08:15 AM	0	1	2	0	3	0	0	1	0	0	2	0	9
08:30 AM	0	1	0	0	4	0	0	0	0	0	2	0	7
08:45 AM	0	1	1	1	0	0	0	0	0	0	2	0	5
<b>Total</b>	<b>0</b>	<b>3</b>	<b>4</b>	<b>1</b>	<b>9</b>	<b>0</b>	<b>0</b>	<b>1</b>	<b>0</b>	<b>0</b>	<b>8</b>	<b>0</b>	<b>26</b>
<b>Grand Total</b>	<b>1</b>	<b>3</b>	<b>6</b>	<b>1</b>	<b>14</b>	<b>0</b>	<b>0</b>	<b>1</b>	<b>0</b>	<b>3</b>	<b>17</b>	<b>1</b>	<b>47</b>
Apprch %	10	30	60	6.7	93.3	0	0	100	0	14.3	81	4.8	
Total %	2.1	6.4	12.8	2.1	29.8	0	0	2.1	0	6.4	36.2	2.1	

Start Time	Alewife Brook Pkwy From North				Broadway From East				Alewife Brook Pkwy From South				Broadway From West				Int. Total	
	Left	Thru	Right	App. Total	Left	Thru	Right	App. Total	Left	Thru	Right	App. Total	Left	Thru	Right	App. Total		
Peak Hour Analysis From 07:00 AM to 08:45 AM - Peak 1 of 1																		
Peak Hour for Entire Intersection Begins at 07:45 AM																		
07:45 AM	0	0	0	0	0	2	0	2	0	0	0	0	0	0	<b>3</b>	0	<b>3</b>	5
08:00 AM	0	0	1	1	0	2	0	2	0	0	0	0	0	2	0	2	2	5
08:15 AM	0	<b>1</b>	<b>2</b>	<b>3</b>	0	3	0	3	0	<b>1</b>	0	<b>1</b>	0	2	0	2	<b>9</b>	7
08:30 AM	0	1	0	1	0	<b>4</b>	0	<b>4</b>	0	0	0	0	0	2	0	2	7	7
Total Volume	0	2	3	5	0	11	0	11	0	1	0	1	0	9	0	9	26	26
% App. Total	0	40	60		0	100	0		0	100	0		0	100	0			
PHF	.000	.500	.375	.417	.000	.688	.000	.688	.000	.250	.000	.250	.000	.750	.000	.750	.722	.722



N/S Street : Alewife Brook Parkway  
E/W Street : Broadway  
City/State : Arlington, MA  
Weather : Clear

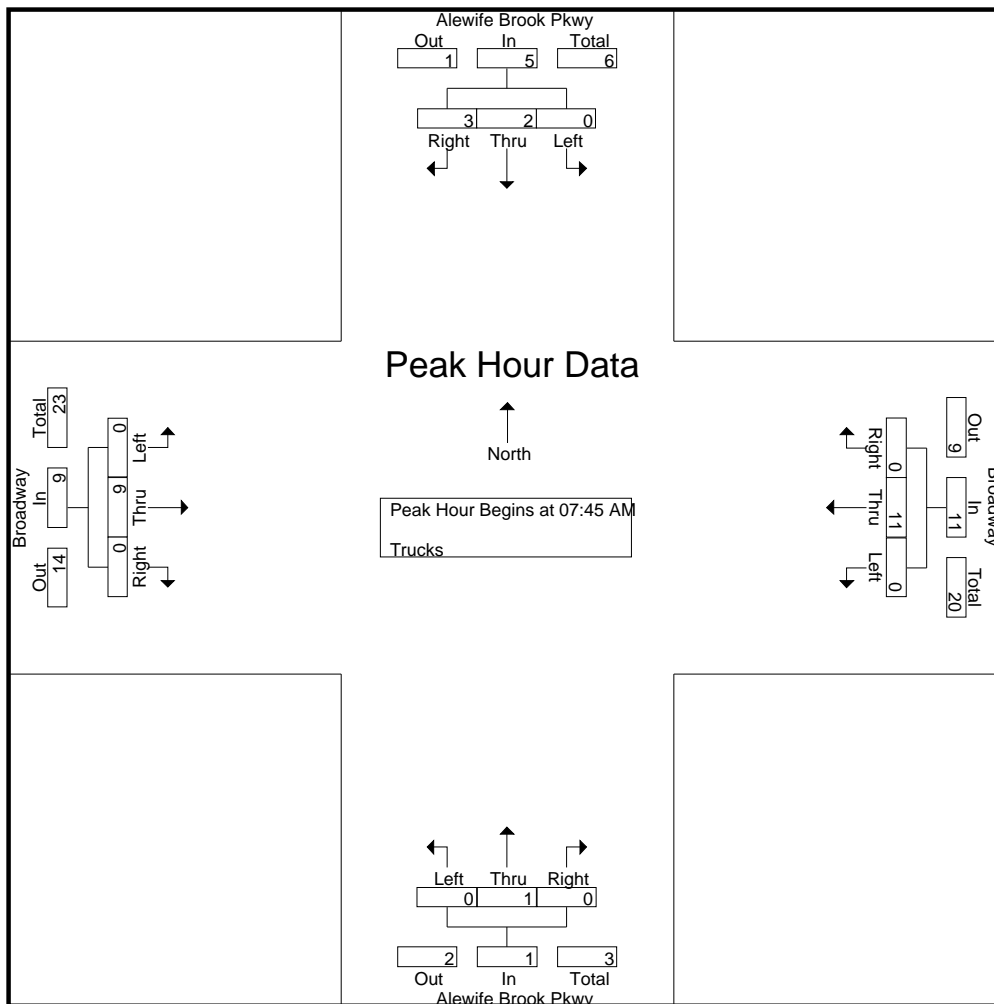

Peak Hour Analysis From 07:00 AM to 08:45 AM - Peak 1 of 1  
Peak Hour for Each Approach Begins at:

	08:00 AM				07:45 AM				07:30 AM				07:15 AM			
+0 mins.	0	0	1	1	0	2	0	2	0	0	0	0	2	4	0	6
+15 mins.	0	1	2	3	0	2	0	2	0	0	0	0	0	2	1	3
+30 mins.	0	1	0	1	0	3	0	3	0	0	0	0	0	3	0	3
+45 mins.	0	1	1	2	0	4	0	4	0	1	0	1	0	2	0	2
Total Volume	0	3	4	7	0	11	0	11	0	1	0	1	2	11	1	14
% App. Total	0	42.9	57.1		0	100	0		0	100	0		14.3	78.6	7.1	
PHF	.000	.750	.500	.583	.000	.688	.000	.688	.000	.250	.000	.250	.250	.688	.250	.583

N/S Street : Alewife Brook Parkway  
E/W Street : Broadway  
City/State : Arlington, MA  
Weather : Clear

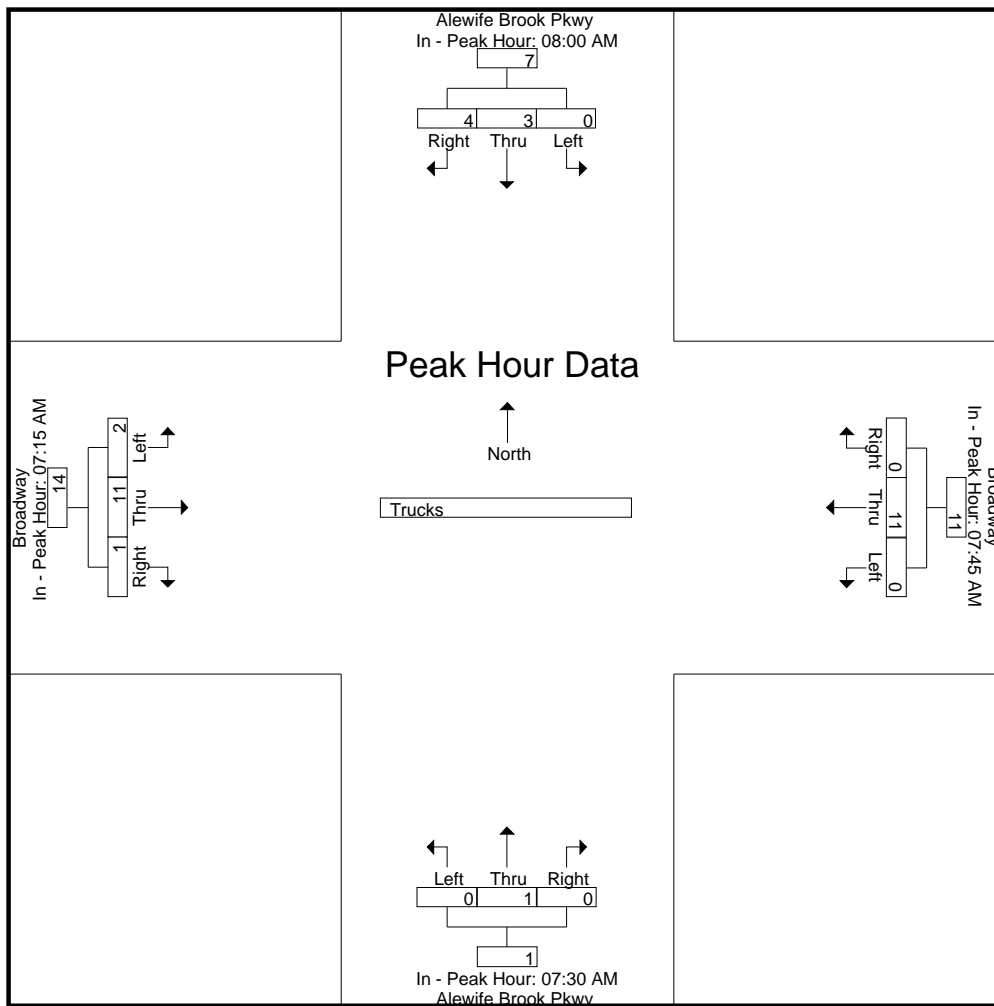

**Accurate Counts**  
978-664-2565

N/S Street : Alewife Brook Parkway  
E/W Street : Broadway  
City/State : Arlington, MA  
Weather : Clear

File Name : 15289001  
Site Code : 15289001  
Start Date : 11/3/2022  
Page No : 10

Groups Printed- Bikes Peds

Start Time	Alewife Brook Pkwy From North				Broadway From East				Alewife Brook Pkwy From South				Broadway From West				Exclu. Total	Inclu. Total	Int. Total
	Left	Thru	Right	Peds	Left	Thru	Right	Peds	Left	Thru	Right	Peds	Left	Thru	Right	Peds			
07:00 AM	0	0	0	2	0	0	1	3	0	0	0	3	0	2	1	0	8	4	12
07:15 AM	0	0	0	2	0	0	0	8	0	0	0	0	1	1	0	1	11	2	13
07:30 AM	0	0	0	5	0	3	3	7	0	3	0	6	0	1	0	3	21	10	31
07:45 AM	2	1	1	5	0	3	7	8	0	4	0	4	1	2	0	0	17	21	38
<b>Total</b>	<b>2</b>	<b>1</b>	<b>1</b>	<b>14</b>	<b>0</b>	<b>6</b>	<b>11</b>	<b>26</b>	<b>0</b>	<b>7</b>	<b>0</b>	<b>13</b>	<b>2</b>	<b>6</b>	<b>1</b>	<b>4</b>	<b>57</b>	<b>37</b>	<b>94</b>
08:00 AM	1	0	0	6	0	9	5	8	2	0	0	6	0	3	0	2	22	20	42
08:15 AM	3	1	1	2	0	4	2	9	0	1	0	11	0	3	0	3	25	15	40
08:30 AM	0	0	0	2	0	1	0	7	0	3	0	7	0	0	0	0	16	4	20
08:45 AM	1	0	0	6	0	3	0	4	0	1	0	8	2	1	0	2	20	8	28
<b>Total</b>	<b>5</b>	<b>1</b>	<b>1</b>	<b>16</b>	<b>0</b>	<b>17</b>	<b>7</b>	<b>28</b>	<b>2</b>	<b>5</b>	<b>0</b>	<b>32</b>	<b>2</b>	<b>7</b>	<b>0</b>	<b>7</b>	<b>83</b>	<b>47</b>	<b>130</b>
<b>Grand Total</b>	<b>7</b>	<b>2</b>	<b>2</b>	<b>30</b>	<b>0</b>	<b>23</b>	<b>18</b>	<b>54</b>	<b>2</b>	<b>12</b>	<b>0</b>	<b>45</b>	<b>4</b>	<b>13</b>	<b>1</b>	<b>11</b>	<b>140</b>	<b>84</b>	<b>224</b>
Apprch %	63.6	18.2	18.2		0	56.1	43.9		14.3	85.7	0		22.2	72.2	5.6				
Total %	8.3	2.4	2.4		0	27.4	21.4		2.4	14.3	0		4.8	15.5	1.2		62.5	37.5	

Start Time	Alewife Brook Pkwy From North				Broadway From East				Alewife Brook Pkwy From South				Broadway From West				Int. Total
	Left	Thru	Right	App. Total	Left	Thru	Right	App. Total	Left	Thru	Right	App. Total	Left	Thru	Right	App. Total	
Peak Hour Analysis From 07:00 AM to 08:45 AM - Peak 1 of 1																	
Peak Hour for Entire Intersection Begins at 07:30 AM																	
07:30 AM	0	0	0	0	0	3	3	6	0	3	0	3	0	1	0	1	10
07:45 AM	2	1	1	4	0	3	7	10	0	4	0	4	1	2	0	3	21
08:00 AM	1	0	0	1	0	9	5	14	2	0	0	2	0	3	0	3	20
08:15 AM	3	1	1	5	0	4	2	6	0	1	0	1	0	3	0	3	15
<b>Total Volume</b>	<b>6</b>	<b>2</b>	<b>2</b>	<b>10</b>	<b>0</b>	<b>19</b>	<b>17</b>	<b>36</b>	<b>2</b>	<b>8</b>	<b>0</b>	<b>10</b>	<b>1</b>	<b>9</b>	<b>0</b>	<b>10</b>	<b>66</b>
<b>% App. Total</b>	<b>60</b>	<b>20</b>	<b>20</b>		<b>0</b>	<b>52.8</b>	<b>47.2</b>		<b>20</b>	<b>80</b>	<b>0</b>		<b>10</b>	<b>90</b>	<b>0</b>		
PHF	.500	.500	.500	.500	.000	.528	.607	.643	.250	.500	.000	.625	.250	.750	.000	.833	.786

N/S Street : Alewife Brook Parkway  
E/W Street : Broadway  
City/State : Arlington, MA  
Weather : Clear

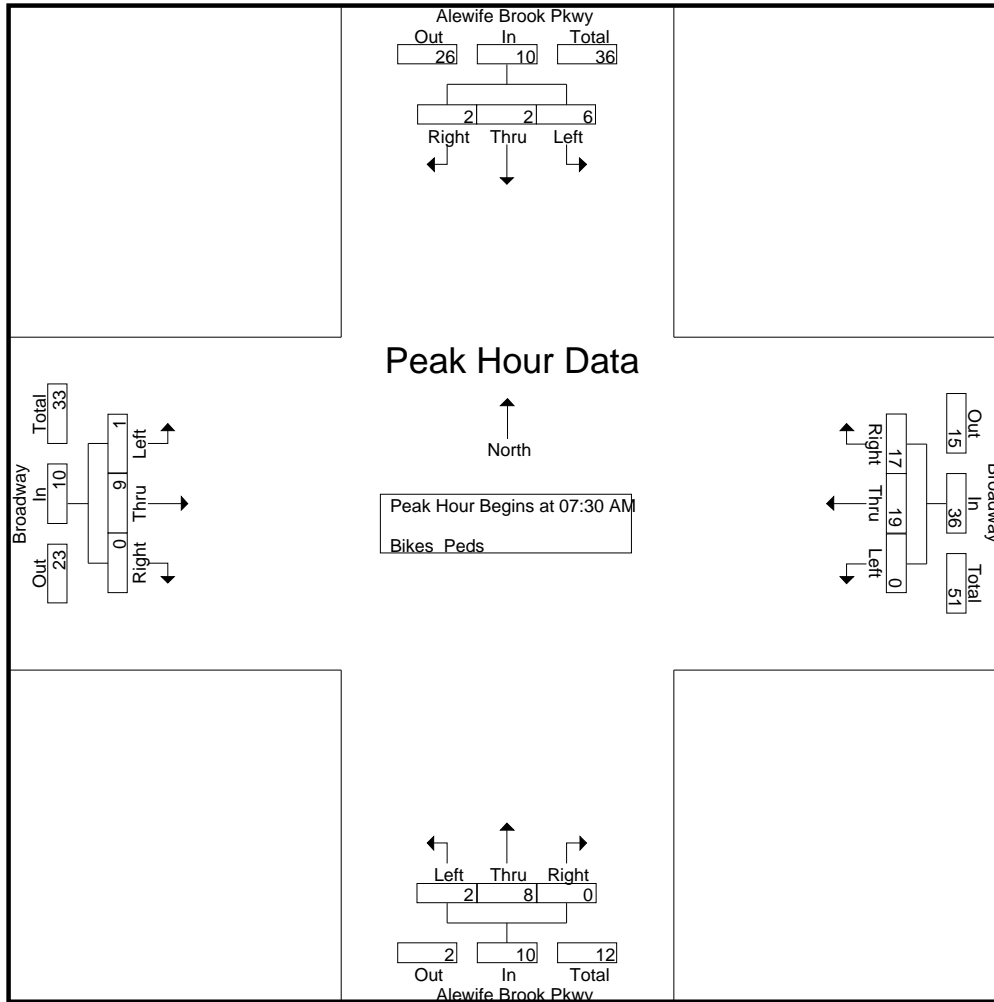

Peak Hour Analysis From 07:00 AM to 08:45 AM - Peak 1 of 1  
Peak Hour for Each Approach Begins at:

	07:30 AM				07:30 AM				07:30 AM				07:30 AM			
+0 mins.	0	0	0	0	0	3	3	6	0	3	0	3	0	1	0	1
+15 mins.	2	1	1	4	0	3	7	10	0	4	0	4	1	2	0	3
+30 mins.	1	0	0	1	0	9	5	14	2	0	0	2	0	3	0	3
+45 mins.	3	1	1	5	0	4	2	6	0	1	0	1	0	3	0	3
Total Volume	6	2	2	10	0	19	17	36	2	8	0	10	1	9	0	10
% App. Total	60	20	20		0	52.8	47.2		20	80	0		10	90	0	
PHF	.500	.500	.500	.500	.000	.528	.607	.643	.250	.500	.000	.625	.250	.750	.000	.833

N/S Street : Alewife Brook Parkway  
E/W Street : Broadway  
City/State : Arlington, MA  
Weather : Clear

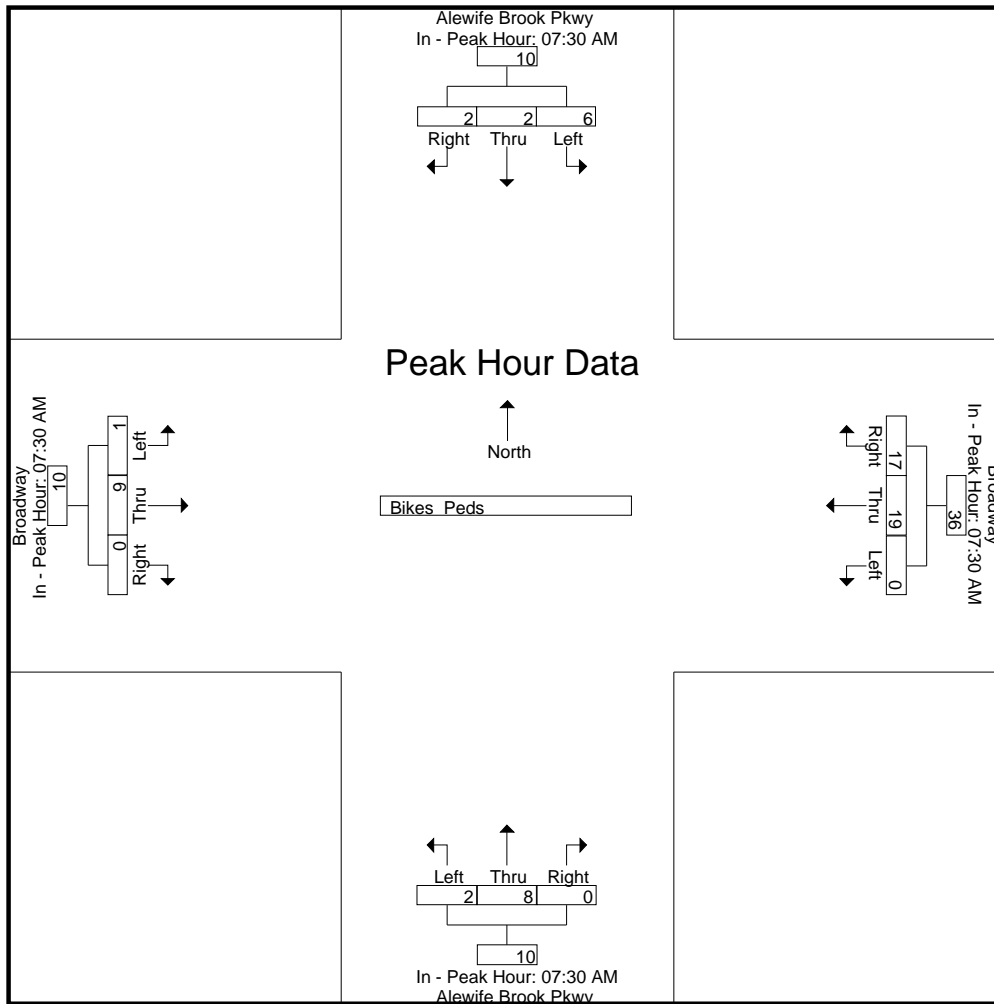

**Accurate Counts**  
978-664-2565

N/S Street : Alewife Brook Parkway  
E/W Street : Broadway  
City/State : Arlington, MA  
Weather : Clear

File Name : 15289001  
Site Code : 15289001  
Start Date : 11/3/2022  
Page No : 1

Groups Printed- Cars - Trucks

Start Time	Alewife Brook Pkwy From North			Broadway From East			Alewife Brook Pkwy From South			Broadway From West			Int. Total
	Left	Thru	Right	Left	Thru	Right	Left	Thru	Right	Left	Thru	Right	
04:00 PM	5	189	33	46	55	5	1	183	16	27	52	2	614
04:15 PM	5	196	25	47	41	9	0	226	19	28	38	4	638
04:30 PM	4	164	30	48	57	12	2	200	20	26	61	4	628
04:45 PM	9	197	23	51	55	9	3	173	16	27	49	4	616
<b>Total</b>	<b>23</b>	<b>746</b>	<b>111</b>	<b>192</b>	<b>208</b>	<b>35</b>	<b>6</b>	<b>782</b>	<b>71</b>	<b>108</b>	<b>200</b>	<b>14</b>	<b>2496</b>
05:00 PM	6	185	36	36	41	11	0	246	21	23	62	5	672
05:15 PM	7	192	44	54	89	5	2	194	22	30	60	2	701
05:30 PM	2	185	34	41	54	3	1	174	31	32	59	3	619
05:45 PM	4	167	33	44	72	6	1	162	29	34	69	6	627
<b>Total</b>	<b>19</b>	<b>729</b>	<b>147</b>	<b>175</b>	<b>256</b>	<b>25</b>	<b>4</b>	<b>776</b>	<b>103</b>	<b>119</b>	<b>250</b>	<b>16</b>	<b>2619</b>
<b>Grand Total</b>	<b>42</b>	<b>1475</b>	<b>258</b>	<b>367</b>	<b>464</b>	<b>60</b>	<b>10</b>	<b>1558</b>	<b>174</b>	<b>227</b>	<b>450</b>	<b>30</b>	<b>5115</b>
Apprch %	2.4	83.1	14.5	41.2	52.1	6.7	0.6	89.4	10	32.1	63.6	4.2	
Total %	0.8	28.8	5	7.2	9.1	1.2	0.2	30.5	3.4	4.4	8.8	0.6	
Cars	42	1473	258	366	455	60	10	1558	174	227	438	30	5091
% Cars	100	99.9	100	99.7	98.1	100	100	100	100	100	97.3	100	99.5
Trucks	0	2	0	1	9	0	0	0	0	0	12	0	24
% Trucks	0	0.1	0	0.3	1.9	0	0	0	0	0	2.7	0	0.5

Start Time	Alewife Brook Pkwy From North				Broadway From East				Alewife Brook Pkwy From South				Broadway From West				Int. Total
	Left	Thru	Right	App. Total	Left	Thru	Right	App. Total	Left	Thru	Right	App. Total	Left	Thru	Right	App. Total	
Peak Hour Analysis From 04:00 PM to 05:45 PM - Peak 1 of 1																	
Peak Hour for Entire Intersection Begins at 05:00 PM																	
05:00 PM	6	185	36	227	36	41	<b>11</b>	88	0	<b>246</b>	21	<b>267</b>	23	62	5	90	672
05:15 PM	<b>7</b>	<b>192</b>	<b>44</b>	<b>243</b>	<b>54</b>	<b>89</b>	5	<b>148</b>	<b>2</b>	194	22	218	30	60	2	92	<b>701</b>
05:30 PM	2	185	34	221	41	54	3	98	1	174	<b>31</b>	206	32	59	3	94	619
05:45 PM	4	167	33	204	44	72	6	122	1	162	29	192	<b>34</b>	<b>69</b>	<b>6</b>	<b>109</b>	627
Total Volume	19	729	147	895	175	256	25	456	4	776	103	883	119	250	16	385	2619
% App. Total	2.1	81.5	16.4		38.4	56.1	5.5		0.5	87.9	11.7		30.9	64.9	4.2		
PHF	.679	.949	.835	.921	.810	.719	.568	.770	.500	.789	.831	.827	.875	.906	.667	.883	.934
Cars	19	729	147	895	175	251	25	451	4	776	103	883	119	244	16	379	2608
% Cars	100	100	100	100	100	98.0	100	98.9	100	100	100	100	100	97.6	100	98.4	99.6
Trucks	0	0	0	0	0	5	0	5	0	0	0	0	0	6	0	6	11
% Trucks	0	0	0	0	0	2.0	0	1.1	0	0	0	0	0	2.4	0	1.6	0.4



N/S Street : Alewife Brook Parkway  
E/W Street : Broadway  
City/State : Arlington, MA  
Weather : Clear

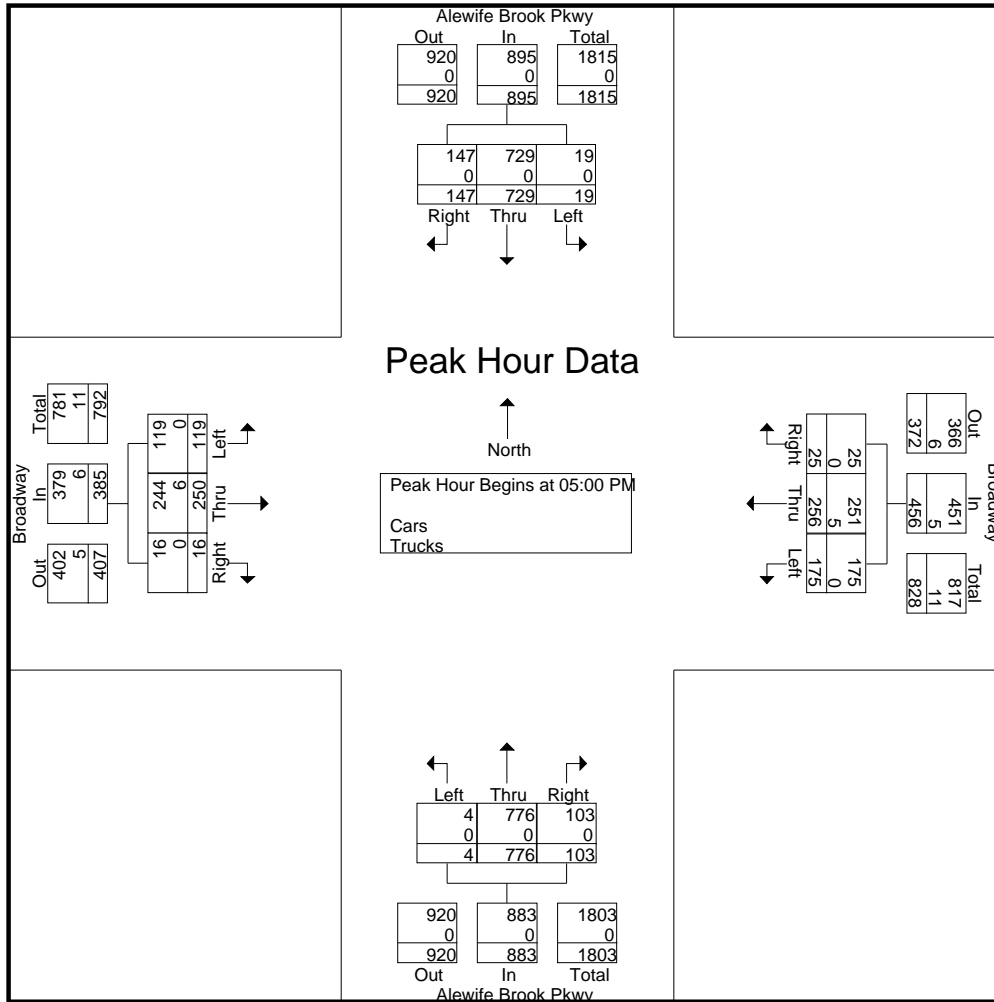

Peak Hour Analysis From 04:00 PM to 05:45 PM - Peak 1 of 1  
Peak Hour for Each Approach Begins at:

	04:45 PM				04:30 PM				04:15 PM				05:00 PM			
+0 mins.	9	197	23	229	48	57	12	117	0	226	19	245	23	62	5	90
+15 mins.	6	185	36	227	51	55	9	115	2	200	20	222	30	60	2	92
+30 mins.	7	192	44	243	36	41	11	88	3	173	16	192	32	59	3	94
+45 mins.	2	185	34	221	54	89	5	148	0	246	21	267	34	69	6	109
Total Volume	24	759	137	920	189	242	37	468	5	845	76	926	119	250	16	385
% App. Total	2.6	82.5	14.9		40.4	51.7	7.9		0.5	91.3	8.2		30.9	64.9	4.2	
PHF	.667	.963	.778	.947	.875	.680	.771	.791	.417	.859	.905	.867	.875	.906	.667	.883
Cars	24	759	137	920	188	236	37	461	5	845	76	926	119	244	16	379
% Cars	100	100	100	100	99.5	97.5	100	98.5	100	100	100	100	100	97.6	100	98.4
Trucks	0	0	0	0	1	6	0	7	0	0	0	0	0	6	0	6
% Trucks	0	0	0	0	0.5	2.5	0	1.5	0	0	0	0	0	2.4	0	1.6

N/S Street : Alewife Brook Parkway  
E/W Street : Broadway  
City/State : Arlington, MA  
Weather : Clear

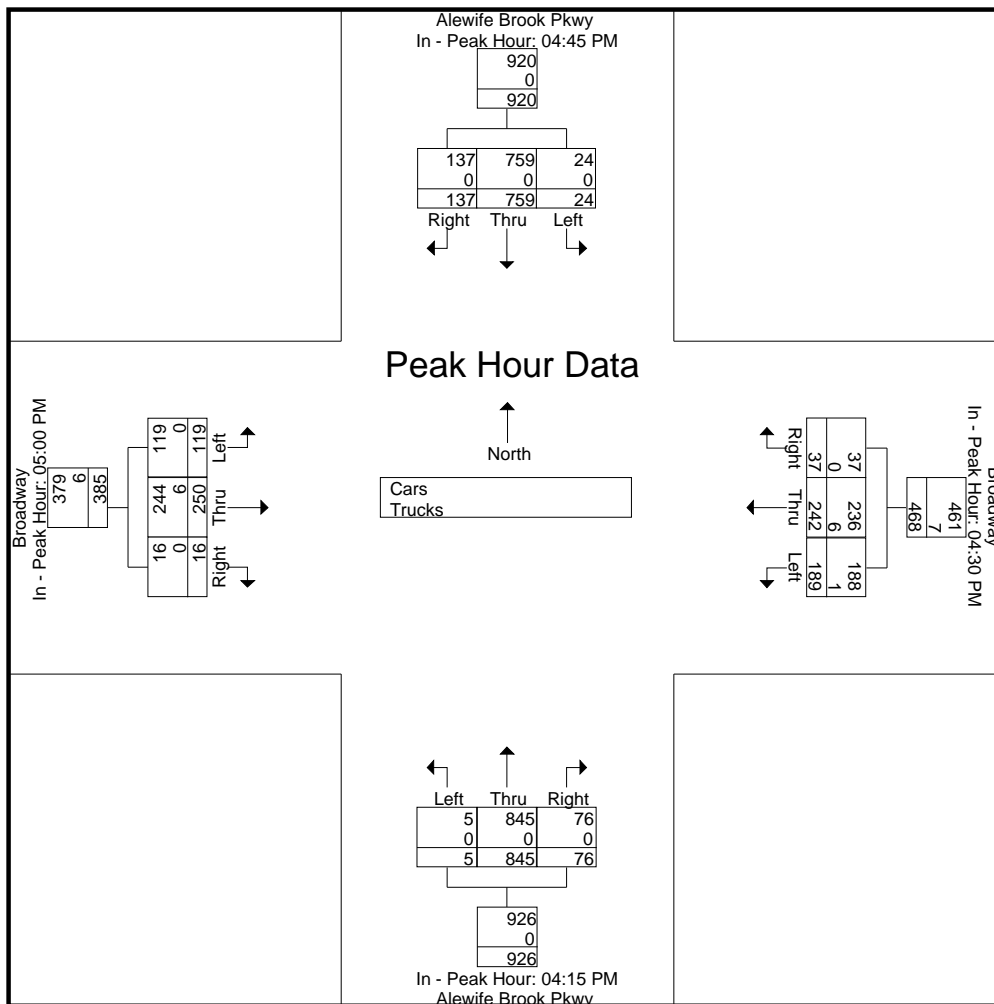

# Accurate Counts

978-664-2565

N/S Street : Alewife Brook Parkway  
 E/W Street : Broadway  
 City/State : Arlington, MA  
 Weather : Clear

File Name : 15289001  
 Site Code : 15289001  
 Start Date : 11/3/2022  
 Page No : 4

## Groups Printed- Cars

Start Time	Alewife Brook Pkwy From North			Broadway From East			Alewife Brook Pkwy From South			Broadway From West			Int. Total
	Left	Thru	Right	Left	Thru	Right	Left	Thru	Right	Left	Thru	Right	
04:00 PM	5	189	33	46	54	5	1	183	16	27	50	2	611
04:15 PM	5	195	25	47	40	9	0	226	19	28	37	4	635
04:30 PM	4	163	30	47	55	12	2	200	20	26	59	4	622
04:45 PM	9	197	23	51	55	9	3	173	16	27	48	4	615
<b>Total</b>	<b>23</b>	<b>744</b>	<b>111</b>	<b>191</b>	<b>204</b>	<b>35</b>	<b>6</b>	<b>782</b>	<b>71</b>	<b>108</b>	<b>194</b>	<b>14</b>	<b>2483</b>
05:00 PM	6	185	36	36	39	11	0	246	21	23	60	5	668
05:15 PM	7	192	44	54	87	5	2	194	22	30	59	2	698
05:30 PM	2	185	34	41	53	3	1	174	31	32	58	3	617
05:45 PM	4	167	33	44	72	6	1	162	29	34	67	6	625
<b>Total</b>	<b>19</b>	<b>729</b>	<b>147</b>	<b>175</b>	<b>251</b>	<b>25</b>	<b>4</b>	<b>776</b>	<b>103</b>	<b>119</b>	<b>244</b>	<b>16</b>	<b>2608</b>
<b>Grand Total</b>	<b>42</b>	<b>1473</b>	<b>258</b>	<b>366</b>	<b>455</b>	<b>60</b>	<b>10</b>	<b>1558</b>	<b>174</b>	<b>227</b>	<b>438</b>	<b>30</b>	<b>5091</b>
Apprch %	2.4	83.1	14.6	41.5	51.6	6.8	0.6	89.4	10	32.7	63	4.3	
Total %	0.8	28.9	5.1	7.2	8.9	1.2	0.2	30.6	3.4	4.5	8.6	0.6	

Start Time	Alewife Brook Pkwy From North				Broadway From East				Alewife Brook Pkwy From South				Broadway From West				Int. Total
	Left	Thru	Right	App. Total	Left	Thru	Right	App. Total	Left	Thru	Right	App. Total	Left	Thru	Right	App. Total	
Peak Hour Analysis From 04:00 PM to 05:45 PM - Peak 1 of 1																	
Peak Hour for Entire Intersection Begins at 05:00 PM																	
05:00 PM	6	185	36	227	36	39	<b>11</b>	86	0	<b>246</b>	21	<b>267</b>	23	60	5	88	668
05:15 PM	<b>7</b>	<b>192</b>	<b>44</b>	<b>243</b>	<b>54</b>	<b>87</b>	5	<b>146</b>	<b>2</b>	194	22	218	30	59	2	91	<b>698</b>
05:30 PM	2	185	34	221	41	53	3	97	1	174	<b>31</b>	206	32	58	3	93	617
05:45 PM	4	167	33	204	44	72	6	122	1	162	29	192	<b>34</b>	<b>67</b>	<b>6</b>	<b>107</b>	625
Total Volume	19	729	147	895	175	251	25	451	4	776	103	883	119	244	16	379	2608
% App. Total	2.1	81.5	16.4		38.8	55.7	5.5		0.5	87.9	11.7		31.4	64.4	4.2		
PHF	.679	.949	.835	.921	.810	.721	.568	.772	.500	.789	.831	.827	.875	.910	.667	.886	.934

N/S Street : Alewife Brook Parkway  
E/W Street : Broadway  
City/State : Arlington, MA  
Weather : Clear

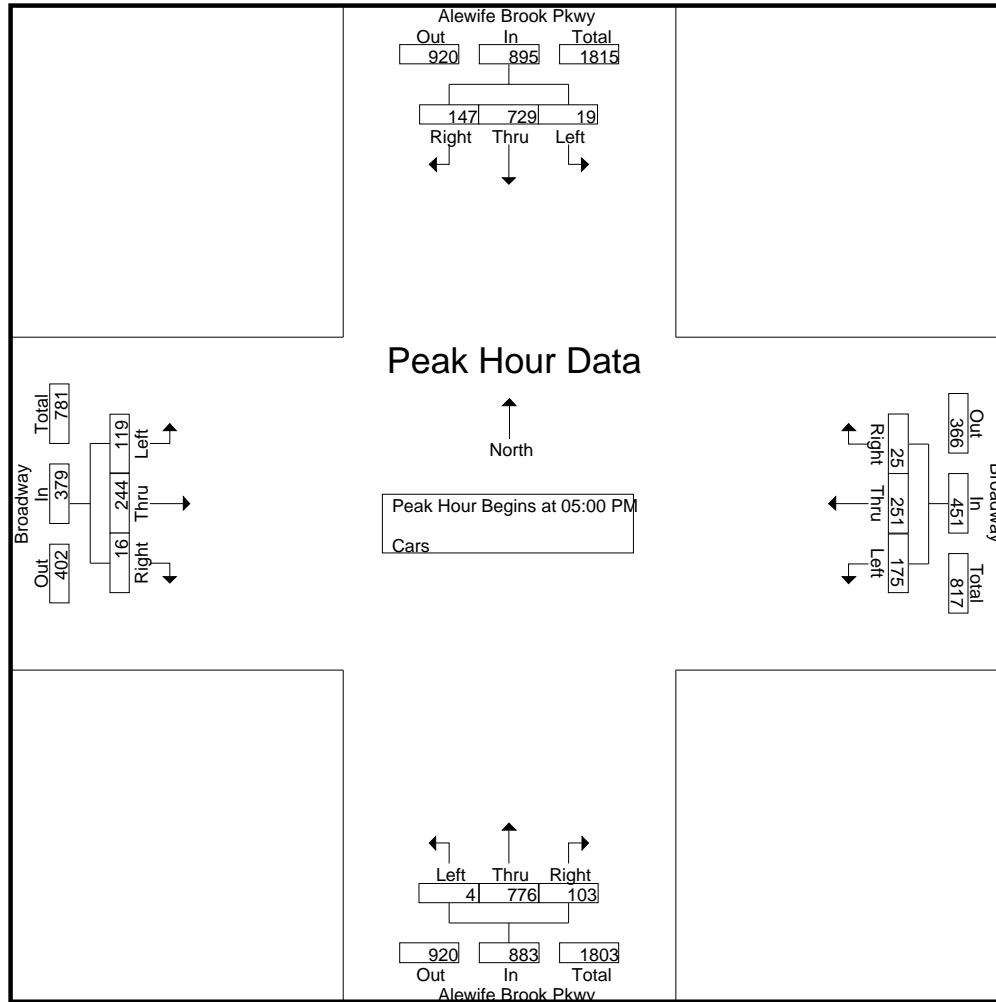

Peak Hour Analysis From 04:00 PM to 05:45 PM - Peak 1 of 1  
Peak Hour for Each Approach Begins at:

	04:45 PM				04:30 PM				04:15 PM				05:00 PM			
+0 mins.	<b>9</b>	<b>197</b>	23	229	47	55	<b>12</b>	114	0	226	19	245	23	60	5	88
+15 mins.	6	185	36	227	51	55	9	115	2	200	20	222	30	59	2	91
+30 mins.	7	192	<b>44</b>	<b>243</b>	36	39	11	86	<b>3</b>	173	16	192	32	58	3	93
+45 mins.	2	185	34	221	<b>54</b>	<b>87</b>	5	<b>146</b>	0	<b>246</b>	<b>21</b>	<b>267</b>	<b>34</b>	<b>67</b>	<b>6</b>	<b>107</b>
Total Volume	24	759	137	920	188	236	37	461	5	845	76	926	119	244	16	379
% App. Total	2.6	82.5	14.9		40.8	51.2	8		0.5	91.3	8.2		31.4	64.4	4.2	
PHF	.667	.963	.778	.947	.870	.678	.771	.789	.417	.859	.905	.867	.875	.910	.667	.886

# Accurate Counts

978-664-2565

File Name : 15289001

Site Code : 15289001

Start Date : 11/3/2022

Page No : 6

N/S Street : Alewife Brook Parkway

E/W Street : Broadway

City/State : Arlington, MA

Weather : Clear

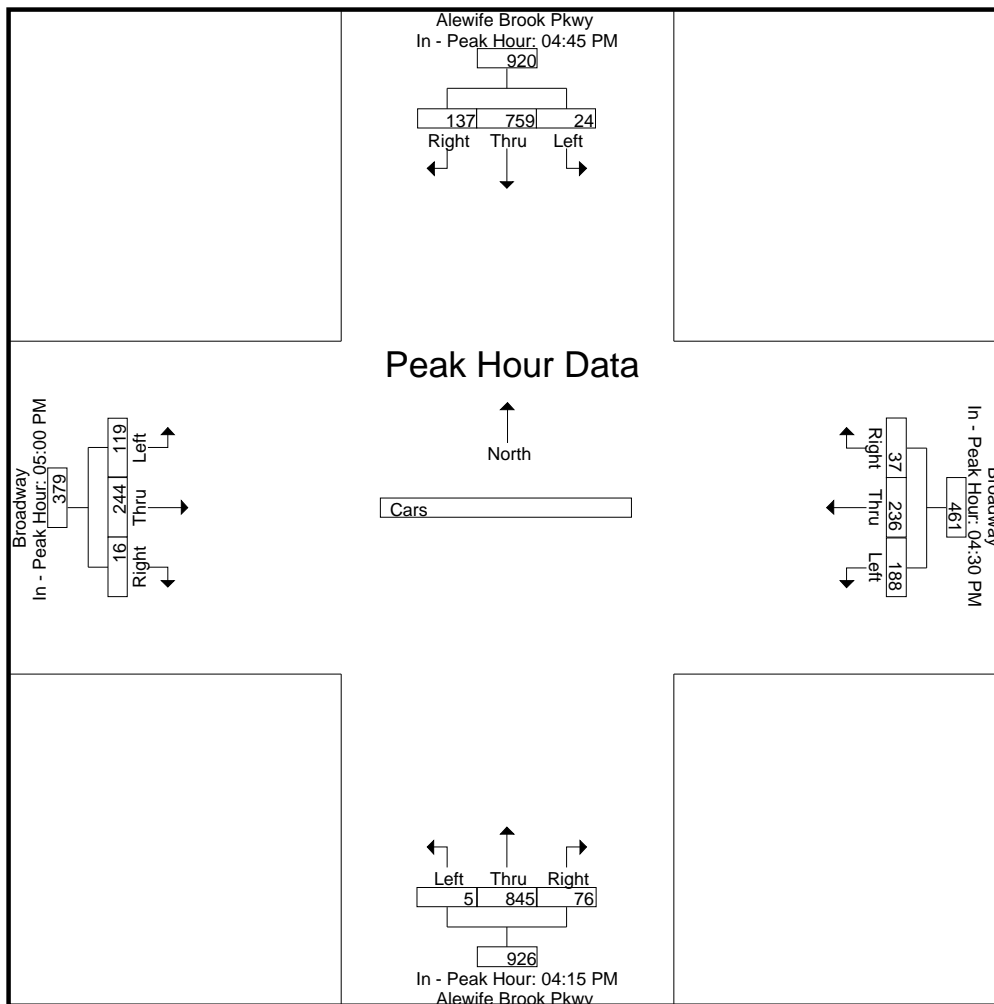

**Accurate Counts**  
978-664-2565

N/S Street : Alewife Brook Parkway  
E/W Street : Broadway  
City/State : Arlington, MA  
Weather : Clear

File Name : 15289001  
Site Code : 15289001  
Start Date : 11/3/2022  
Page No : 7

Groups Printed- Trucks

Start Time	Alewife Brook Pkwy From North			Broadway From East			Alewife Brook Pkwy From South			Broadway From West			Int. Total
	Left	Thru	Right	Left	Thru	Right	Left	Thru	Right	Left	Thru	Right	
04:00 PM	0	0	0	0	1	0	0	0	0	0	2	0	3
04:15 PM	0	1	0	0	1	0	0	0	0	0	1	0	3
04:30 PM	0	1	0	1	2	0	0	0	0	0	2	0	6
04:45 PM	0	0	0	0	0	0	0	0	0	0	1	0	1
Total	0	2	0	1	4	0	0	0	0	0	6	0	13
05:00 PM	0	0	0	0	2	0	0	0	0	0	2	0	4
05:15 PM	0	0	0	0	2	0	0	0	0	0	1	0	3
05:30 PM	0	0	0	0	1	0	0	0	0	0	1	0	2
05:45 PM	0	0	0	0	0	0	0	0	0	0	2	0	2
Total	0	0	0	0	5	0	0	0	0	0	6	0	11
Grand Total	0	2	0	1	9	0	0	0	0	0	12	0	24
Apprch %	0	100	0	10	90	0	0	0	0	0	100	0	
Total %	0	8.3	0	4.2	37.5	0	0	0	0	0	50	0	

Start Time	Alewife Brook Pkwy From North				Broadway From East				Alewife Brook Pkwy From South				Broadway From West				Int. Total	
	Left	Thru	Right	App. Total	Left	Thru	Right	App. Total	Left	Thru	Right	App. Total	Left	Thru	Right	App. Total		
Peak Hour Analysis From 04:00 PM to 05:45 PM - Peak 1 of 1																		
Peak Hour for Entire Intersection Begins at 04:15 PM																		
04:15 PM	0	1	0	1	0	1	0	1	0	0	0	0	0	0	1	0	1	3
04:30 PM	0	1	0	1	1	2	0	3	0	0	0	0	0	2	0	2	0	6
04:45 PM	0	0	0	0	0	0	0	0	0	0	0	0	0	1	0	1	0	1
05:00 PM	0	0	0	0	0	2	0	2	0	0	0	0	0	2	0	2	0	4
Total Volume	0	2	0	2	1	5	0	6	0	0	0	0	0	6	0	6	0	14
% App. Total	0	100	0		16.7	83.3	0		0	0	0	0	0	100	0			
PHF	.000	.500	.000	.500	.250	.625	.000	.500	.000	.000	.000	.000	.000	.750	.000	.750	.000	.583



N/S Street : Alewife Brook Parkway  
E/W Street : Broadway  
City/State : Arlington, MA  
Weather : Clear

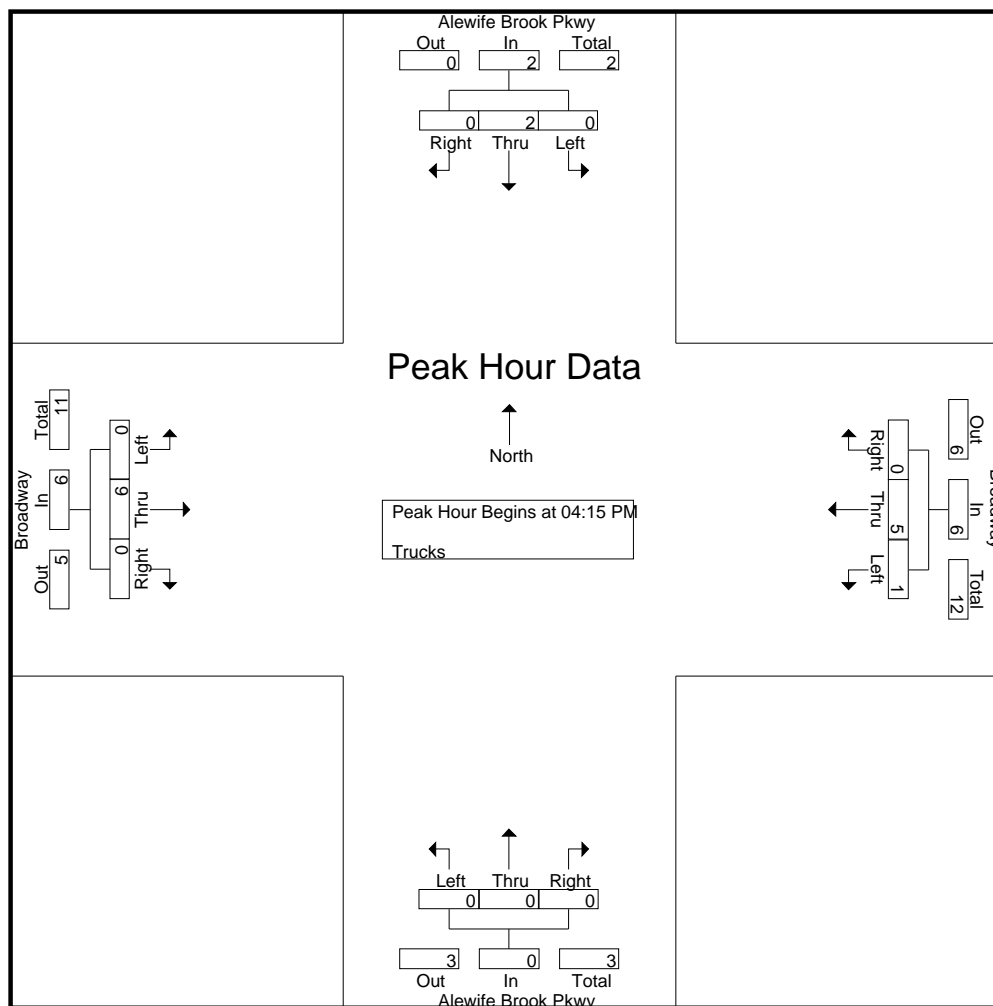

Peak Hour Analysis From 04:00 PM to 05:45 PM - Peak 1 of 1  
Peak Hour for Each Approach Begins at:

	04:00 PM				04:30 PM				04:00 PM				04:00 PM			
+0 mins.	0	0	0	0	1	2	0	3	0	0	0	0	0	2	0	2
+15 mins.	0	1	0	1	0	0	0	0	0	0	0	0	0	1	0	1
+30 mins.	0	1	0	1	0	2	0	2	0	0	0	0	0	2	0	2
+45 mins.	0	0	0	0	0	2	0	2	0	0	0	0	0	1	0	1
Total Volume	0	2	0	2	1	6	0	7	0	0	0	0	0	6	0	6
% App. Total	0	100	0	0	14.3	85.7	0	0	0	0	0	0	0	100	0	0
PHF	.000	.500	.000	.500	.250	.750	.000	.583	.000	.000	.000	.000	.000	.750	.000	.750

N/S Street : Alewife Brook Parkway  
E/W Street : Broadway  
City/State : Arlington, MA  
Weather : Clear

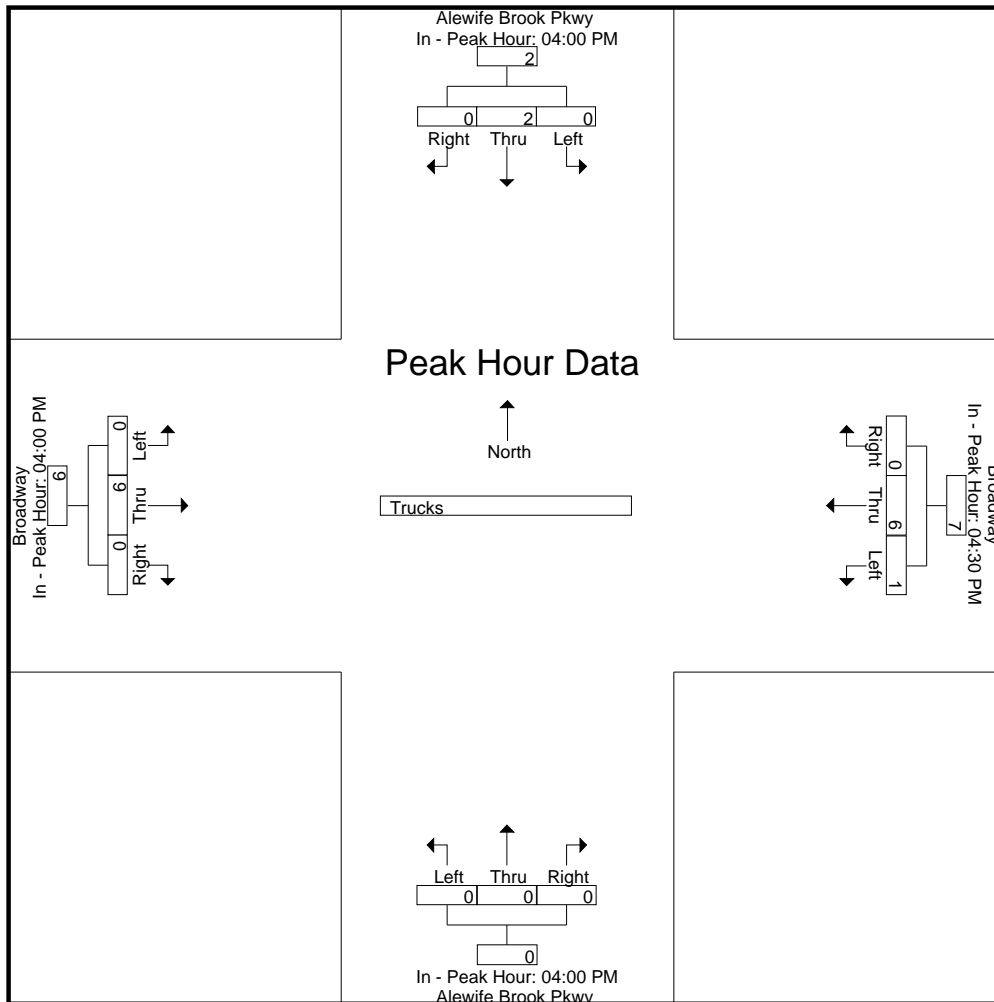

# Accurate Counts

978-664-2565

N/S Street : Alewife Brook Parkway  
 E/W Street : Broadway  
 City/State : Arlington, MA  
 Weather : Clear

File Name : 15289001  
 Site Code : 15289001  
 Start Date : 11/3/2022  
 Page No : 10

## Groups Printed- Bikes Peds

Start Time	Alewife Brook Pkwy From North				Broadway From East				Alewife Brook Pkwy From South				Broadway From West				Exclu. Total	Inclu. Total	Int. Total
	Left	Thru	Right	Peds	Left	Thru	Right	Peds	Left	Thru	Right	Peds	Left	Thru	Right	Peds			
04:00 PM	1	1	0	16	0	2	0	6	0	0	0	10	0	2	0	2	34	6	40
04:15 PM	1	5	1	7	0	2	1	5	0	0	0	11	0	5	0	3	26	15	41
04:30 PM	4	1	0	6	2	1	1	9	0	2	0	14	1	4	0	3	32	16	48
04:45 PM	3	3	0	9	1	2	1	12	0	1	0	22	0	3	0	0	43	14	57
<b>Total</b>	<b>9</b>	<b>10</b>	<b>1</b>	<b>38</b>	<b>3</b>	<b>7</b>	<b>3</b>	<b>32</b>	<b>0</b>	<b>3</b>	<b>0</b>	<b>57</b>	<b>1</b>	<b>14</b>	<b>0</b>	<b>8</b>	<b>135</b>	<b>51</b>	<b>186</b>
05:00 PM	2	2	0	7	0	0	1	10	0	0	0	13	1	2	0	3	33	8	41
05:15 PM	3	1	1	3	0	4	2	25	0	0	0	29	1	4	0	9	66	16	82
05:30 PM	4	4	0	11	0	1	0	15	0	0	0	24	0	0	0	7	57	9	66
05:45 PM	0	3	1	10	1	1	1	12	0	0	0	9	0	4	0	5	36	11	47
<b>Total</b>	<b>9</b>	<b>10</b>	<b>2</b>	<b>31</b>	<b>1</b>	<b>6</b>	<b>4</b>	<b>62</b>	<b>0</b>	<b>0</b>	<b>0</b>	<b>75</b>	<b>2</b>	<b>10</b>	<b>0</b>	<b>24</b>	<b>192</b>	<b>44</b>	<b>236</b>
<b>Grand Total</b>	<b>18</b>	<b>20</b>	<b>3</b>	<b>69</b>	<b>4</b>	<b>13</b>	<b>7</b>	<b>94</b>	<b>0</b>	<b>3</b>	<b>0</b>	<b>132</b>	<b>3</b>	<b>24</b>	<b>0</b>	<b>32</b>	<b>327</b>	<b>95</b>	<b>422</b>
Apprch %	43.9	48.8	7.3		16.7	54.2	29.2		0	100	0		11.1	88.9	0				
Total %	18.9	21.1	3.2		4.2	13.7	7.4		0	3.2	0		3.2	25.3	0		77.5	22.5	

Start Time	Alewife Brook Pkwy From North				Broadway From East				Alewife Brook Pkwy From South				Broadway From West				Int. Total
	Left	Thru	Right	App. Total	Left	Thru	Right	App. Total	Left	Thru	Right	App. Total	Left	Thru	Right	App. Total	
Peak Hour Analysis From 04:00 PM to 05:45 PM - Peak 1 of 1																	
Peak Hour for Entire Intersection Begins at 04:30 PM																	
04:30 PM	4	1	0	5	2	1	1	4	0	2	0	2	1	4	0	5	16
04:45 PM	3	3	0	6	1	2	1	4	0	1	0	1	0	3	0	3	14
05:00 PM	2	2	0	4	0	0	1	1	0	0	0	0	1	2	0	3	8
05:15 PM	3	1	1	5	0	4	2	6	0	0	0	0	1	4	0	5	16
<b>Total Volume</b>	<b>12</b>	<b>7</b>	<b>1</b>	<b>20</b>	<b>3</b>	<b>7</b>	<b>5</b>	<b>15</b>	<b>0</b>	<b>3</b>	<b>0</b>	<b>3</b>	<b>3</b>	<b>13</b>	<b>0</b>	<b>16</b>	<b>54</b>
<b>% App. Total</b>	<b>60</b>	<b>35</b>	<b>5</b>		<b>20</b>	<b>46.7</b>	<b>33.3</b>		<b>0</b>	<b>100</b>	<b>0</b>		<b>18.8</b>	<b>81.2</b>	<b>0</b>		
PHF	.750	.583	.250	.833	.375	.438	.625	.625	.000	.375	.000	.375	.750	.813	.000	.800	.844

N/S Street : Alewife Brook Parkway  
E/W Street : Broadway  
City/State : Arlington, MA  
Weather : Clear

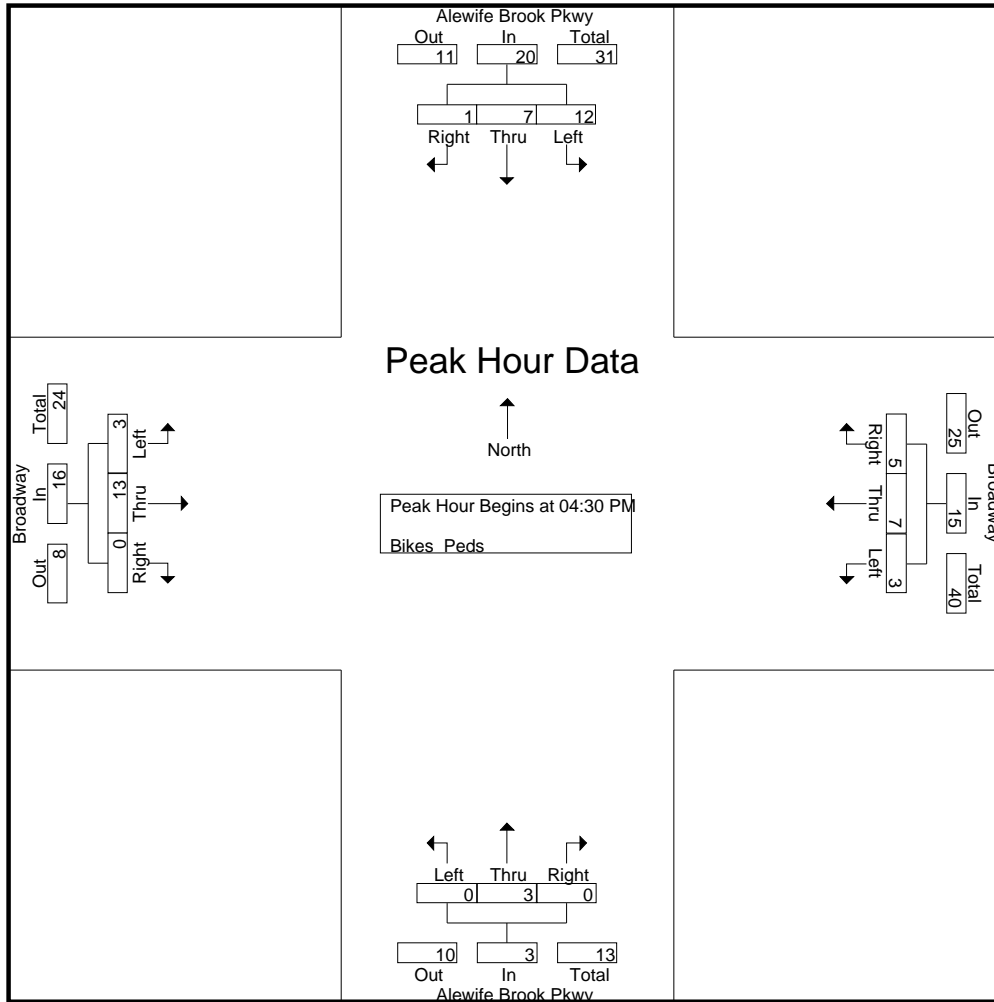

Peak Hour Analysis From 04:00 PM to 05:45 PM - Peak 1 of 1  
Peak Hour for Each Approach Begins at:

	04:45 PM				04:30 PM				04:00 PM				04:15 PM			
+0 mins.	3	3	0	6	2	1	1	4	0	0	0	0	0	5	0	5
+15 mins.	2	2	0	4	1	2	1	4	0	0	0	0	1	4	0	5
+30 mins.	3	1	1	5	0	0	1	1	0	2	0	2	0	3	0	3
+45 mins.	4	4	0	8	0	4	2	6	0	1	0	1	1	2	0	3
Total Volume	12	10	1	23	3	7	5	15	0	3	0	3	2	14	0	16
% App. Total	52.2	43.5	4.3		20	46.7	33.3		0	100	0		12.5	87.5	0	
PHF	.750	.625	.250	.719	.375	.438	.625	.625	.000	.375	.000	.375	.500	.700	.000	.800

N/S Street : Alewife Brook Parkway  
E/W Street : Broadway  
City/State : Arlington, MA  
Weather : Clear

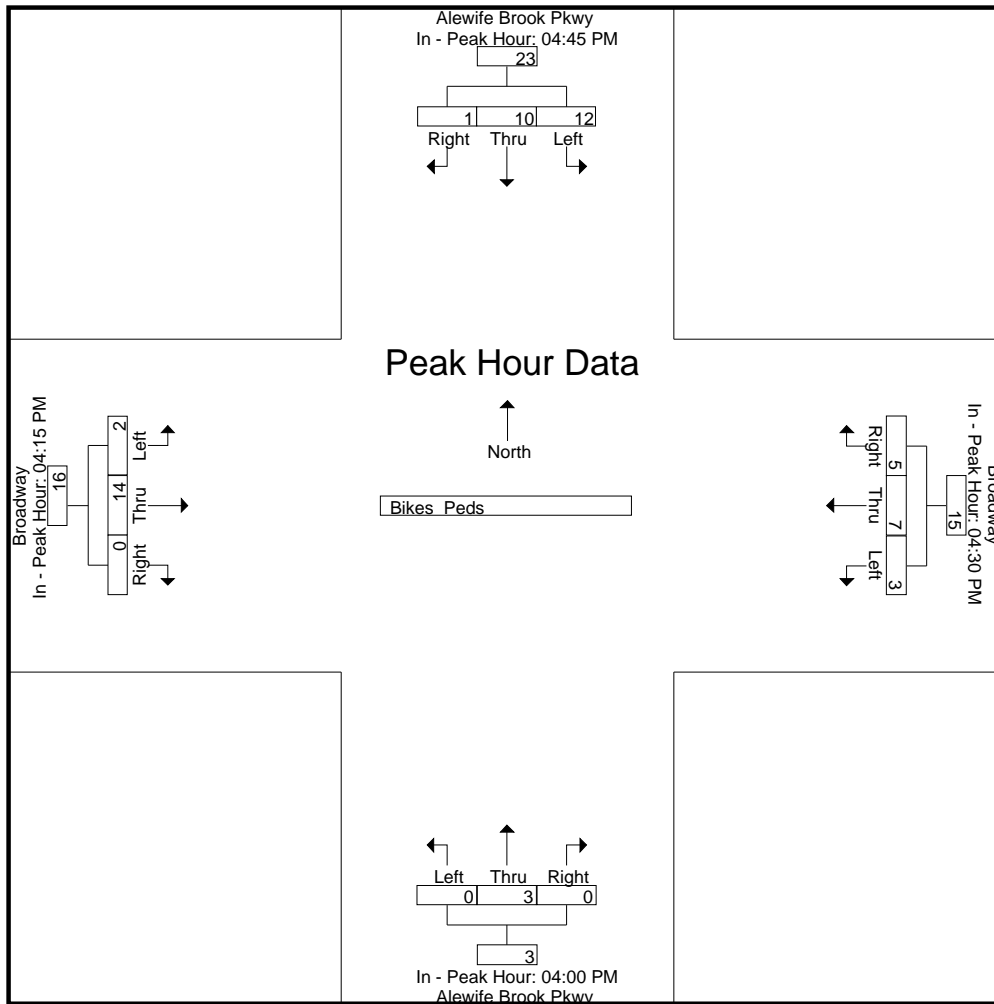

# Accurate Counts

978-664-2565

N/S Street : Sunnyside Avenue  
 E/W Street : Broadway  
 City/State : Arlington, MA  
 Weather : Clear

File Name : 15289002  
 Site Code : 15289002  
 Start Date : 11/3/2022  
 Page No : 1

### Groups Printed- Cars - Trucks

Start Time	Sunnyside Ave From North		Broadway From East		Broadway From West		Int. Total
	Left	Right	Thru	Right	Left	Thru	
07:00 AM	2	7	34	1	3	71	118
07:15 AM	1	5	55	0	2	89	152
07:30 AM	2	5	79	1	3	118	208
07:45 AM	5	1	84	1	1	120	212
<b>Total</b>	<b>10</b>	<b>18</b>	<b>252</b>	<b>3</b>	<b>9</b>	<b>398</b>	<b>690</b>
08:00 AM	4	1	68	0	1	109	183
08:15 AM	2	6	68	0	0	111	187
08:30 AM	3	6	77	1	2	96	185
08:45 AM	2	1	56	0	1	123	183
<b>Total</b>	<b>11</b>	<b>14</b>	<b>269</b>	<b>1</b>	<b>4</b>	<b>439</b>	<b>738</b>
<b>Grand Total</b>	<b>21</b>	<b>32</b>	<b>521</b>	<b>4</b>	<b>13</b>	<b>837</b>	<b>1428</b>
Apprch %	39.6	60.4	99.2	0.8	1.5	98.5	
Total %	1.5	2.2	36.5	0.3	0.9	58.6	
Cars	21	32	505	4	12	822	1396
% Cars	100	100	96.9	100	92.3	98.2	97.8
Trucks	0	0	16	0	1	15	32
% Trucks	0	0	3.1	0	7.7	1.8	2.2

Start Time	Sunnyside Ave From North			Broadway From East			Broadway From West			Int. Total
	Left	Right	App. Total	Thru	Right	App. Total	Left	Thru	App. Total	
Peak Hour Analysis From 07:00 AM to 08:45 AM - Peak 1 of 1										
Peak Hour for Entire Intersection Begins at 07:30 AM										
07:30 AM	2	5	7	79	1	80	3	118	121	208
07:45 AM	5	1	6	84	1	85	1	120	121	212
08:00 AM	4	1	5	68	0	68	1	109	110	183
08:15 AM	2	6	8	68	0	68	0	111	111	187
Total Volume	13	13	26	299	2	301	5	458	463	790
% App. Total	50	50	100	99.3	0.7	100	1.1	98.9	100	99.3
PHF	.650	.542	.813	.890	.500	.885	.417	.954	.957	.932
Cars	13	13	26	291	2	293	5	451	456	775
% Cars	100	100	100	97.3	100	97.3	100	98.5	98.5	98.1
Trucks	0	0	0	8	0	8	0	7	7	15
% Trucks	0	0	0	2.7	0	2.7	0	1.5	1.5	1.9



N/S Street : Sunnyside Avenue  
E/W Street : Broadway  
City/State : Arlington, MA  
Weather : Clear

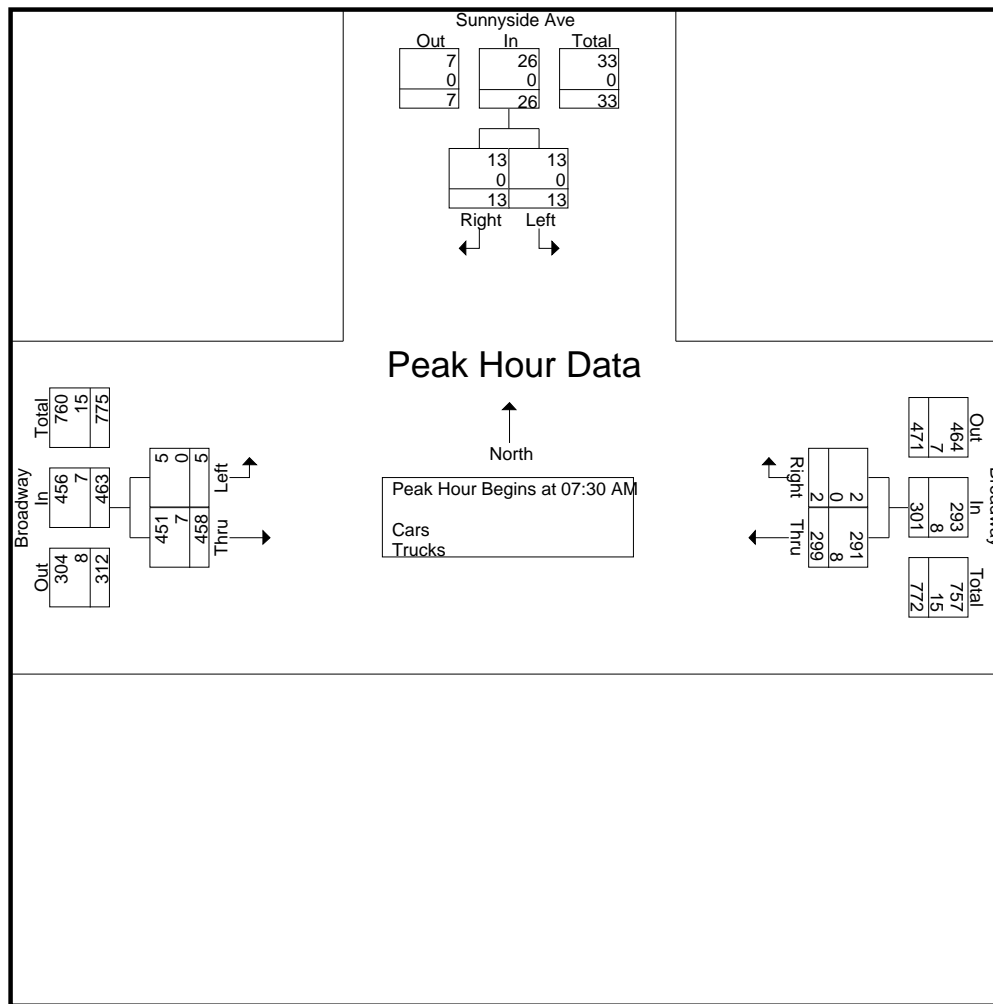

Peak Hour Analysis From 07:00 AM to 08:45 AM - Peak 1 of 1  
Peak Hour for Each Approach Begins at:

	07:00 AM			07:30 AM			07:30 AM		
+0 mins.	2	7	9	79	1	80	3	118	121
+15 mins.	1	5	6	84	1	85	1	120	121
+30 mins.	2	5	7	68	0	68	1	109	110
+45 mins.	5	1	6	68	0	68	0	111	111
Total Volume	10	18	28	299	2	301	5	458	463
% App. Total	35.7	64.3		99.3	0.7		1.1	98.9	
PHF	.500	.643	.778	.890	.500	.885	.417	.954	.957
Cars	10	18	28	291	2	293	5	451	456
% Cars	100	100	100	97.3	100	97.3	100	98.5	98.5
Trucks	0	0	0	8	0	8	0	7	7
% Trucks	0	0	0	2.7	0	2.7	0	1.5	1.5

N/S Street : Sunnyside Avenue  
E/W Street : Broadway  
City/State : Arlington, MA  
Weather : Clear

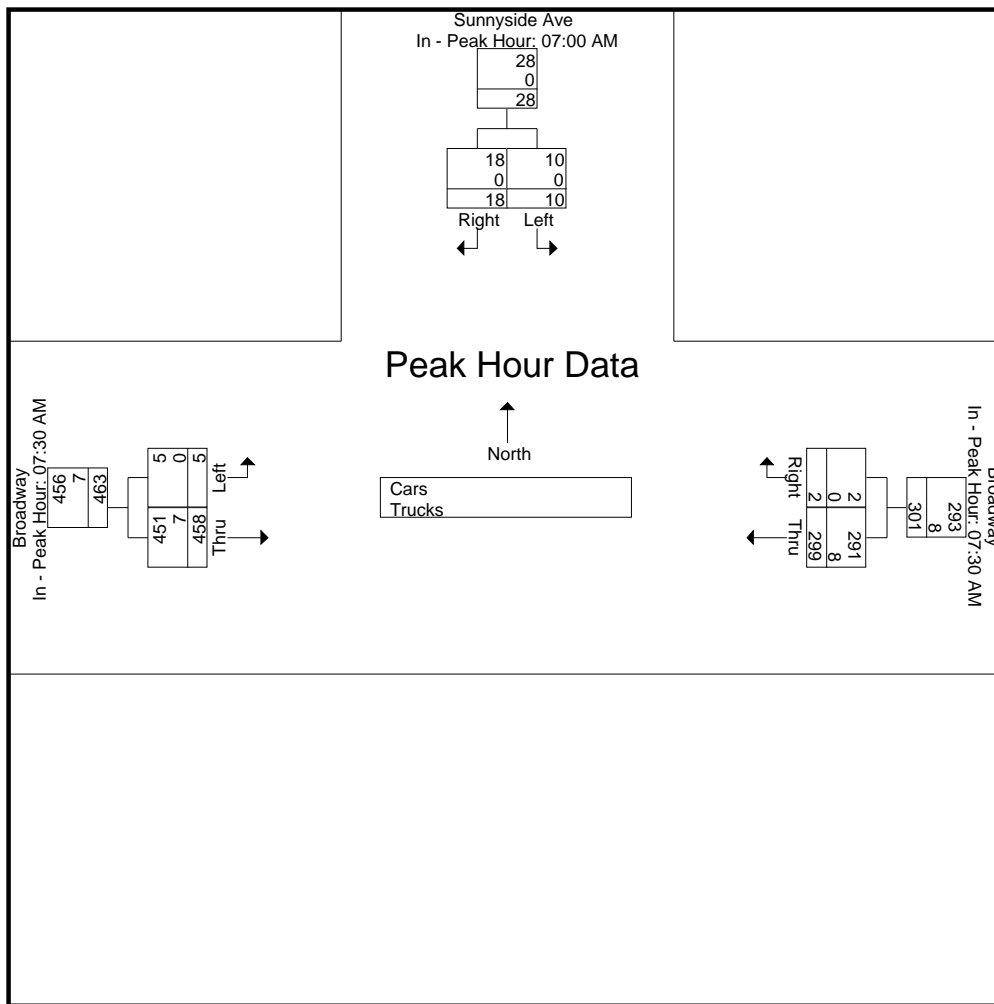

# Accurate Counts

978-664-2565

N/S Street : Sunnyside Avenue  
 E/W Street : Broadway  
 City/State : Arlington, MA  
 Weather : Clear

File Name : 15289002  
 Site Code : 15289002  
 Start Date : 11/3/2022  
 Page No : 4

### Groups Printed- Cars

Start Time	Sunnyside Ave From North		Broadway From East		Broadway From West		Int. Total
	Left	Right	Thru	Right	Left	Thru	
07:00 AM	2	7	34	1	3	70	117
07:15 AM	1	5	51	0	1	88	146
07:30 AM	2	5	78	1	3	118	207
07:45 AM	5	1	82	1	1	118	208
<b>Total</b>	<b>10</b>	<b>18</b>	<b>245</b>	<b>3</b>	<b>8</b>	<b>394</b>	<b>678</b>
08:00 AM	4	1	65	0	1	107	178
08:15 AM	2	6	66	0	0	108	182
08:30 AM	3	6	75	1	2	92	179
08:45 AM	2	1	54	0	1	121	179
<b>Total</b>	<b>11</b>	<b>14</b>	<b>260</b>	<b>1</b>	<b>4</b>	<b>428</b>	<b>718</b>
<b>Grand Total</b>	<b>21</b>	<b>32</b>	<b>505</b>	<b>4</b>	<b>12</b>	<b>822</b>	<b>1396</b>
Apprch %	39.6	60.4	99.2	0.8	1.4	98.6	
Total %	1.5	2.3	36.2	0.3	0.9	58.9	

Start Time	Sunnyside Ave From North			Broadway From East			Broadway From West			Int. Total
	Left	Right	App. Total	Thru	Right	App. Total	Left	Thru	App. Total	
Peak Hour Analysis From 07:00 AM to 08:45 AM - Peak 1 of 1										
Peak Hour for Entire Intersection Begins at 07:30 AM										
07:30 AM	2	5	7	78	1	79	3	118	121	207
07:45 AM	5	1	6	82	1	83	1	118	119	208
08:00 AM	4	1	5	65	0	65	1	107	108	178
08:15 AM	2	6	8	66	0	66	0	108	108	182
Total Volume	13	13	26	291	2	293	5	451	456	775
% App. Total	50	50		99.3	0.7		1.1	98.9		
PHF	.650	.542	.813	.887	.500	.883	.417	.956	.942	.931

N/S Street : Sunnyside Avenue  
E/W Street : Broadway  
City/State : Arlington, MA  
Weather : Clear

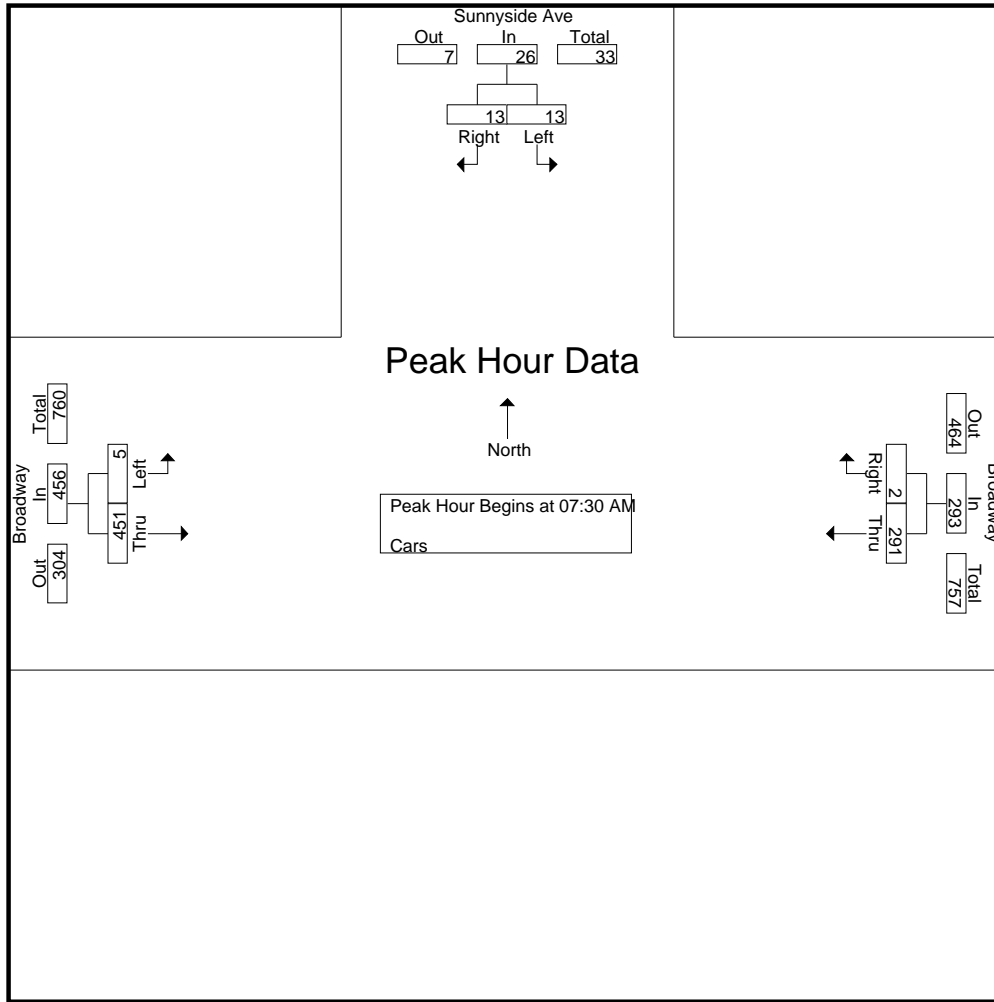

Peak Hour Analysis From 07:00 AM to 08:45 AM - Peak 1 of 1  
Peak Hour for Each Approach Begins at:

	07:00 AM			07:30 AM			07:30 AM		
+0 mins.	2	7	9	78	1	79	3	118	121
+15 mins.	1	5	6	82	1	83	1	118	119
+30 mins.	2	5	7	65	0	65	1	107	108
+45 mins.	5	1	6	66	0	66	0	108	108
Total Volume	10	18	28	291	2	293	5	451	456
% App. Total	35.7	64.3		99.3	0.7		1.1	98.9	
PHF	.500	.643	.778	.887	.500	.883	.417	.956	.942

N/S Street : Sunnyside Avenue  
E/W Street : Broadway  
City/State : Arlington, MA  
Weather : Clear

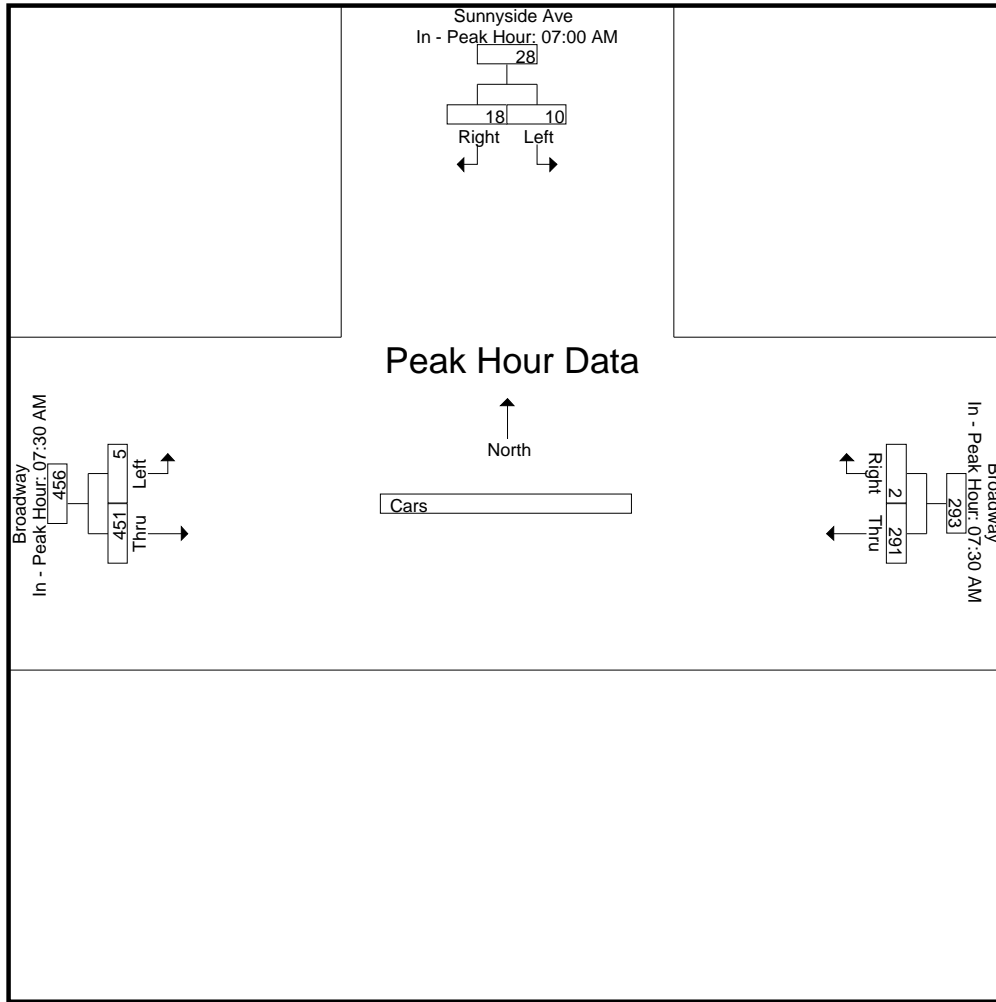

**Accurate Counts**  
978-664-2565

N/S Street : Sunnyside Avenue  
E/W Street : Broadway  
City/State : Arlington, MA  
Weather : Clear

File Name : 15289002  
Site Code : 15289002  
Start Date : 11/3/2022  
Page No : 7

Groups Printed- Trucks

Start Time	Sunnyside Ave From North		Broadway From East		Broadway From West		Int. Total
	Left	Right	Thru	Right	Left	Thru	
07:00 AM	0	0	0	0	0	1	1
07:15 AM	0	0	4	0	1	1	6
07:30 AM	0	0	1	0	0	0	1
07:45 AM	0	0	2	0	0	2	4
<b>Total</b>	<b>0</b>	<b>0</b>	<b>7</b>	<b>0</b>	<b>1</b>	<b>4</b>	<b>12</b>
08:00 AM	0	0	3	0	0	2	5
08:15 AM	0	0	2	0	0	3	5
08:30 AM	0	0	2	0	0	4	6
08:45 AM	0	0	2	0	0	2	4
<b>Total</b>	<b>0</b>	<b>0</b>	<b>9</b>	<b>0</b>	<b>0</b>	<b>11</b>	<b>20</b>
<b>Grand Total</b>	<b>0</b>	<b>0</b>	<b>16</b>	<b>0</b>	<b>1</b>	<b>15</b>	<b>32</b>
Apprch %	0	0	100	0	6.2	93.8	
Total %	0	0	50	0	3.1	46.9	

Start Time	Sunnyside Ave From North			Broadway From East			Broadway From West			Int. Total
	Left	Right	App. Total	Thru	Right	App. Total	Left	Thru	App. Total	
Peak Hour Analysis From 07:00 AM to 08:45 AM - Peak 1 of 1										
Peak Hour for Entire Intersection Begins at 07:45 AM										
07:45 AM	0	0	0	2	0	2	0	2	2	4
08:00 AM	0	0	0	3	0	3	0	2	2	5
08:15 AM	0	0	0	2	0	2	0	3	3	5
08:30 AM	0	0	0	2	0	2	0	4	4	6
Total Volume	0	0	0	9	0	9	0	11	11	20
% App. Total	0	0	0	100	0	100	0	100	100	100
PHF	.000	.000	.000	.750	.000	.750	.000	.688	.688	.833



N/S Street : Sunnyside Avenue  
E/W Street : Broadway  
City/State : Arlington, MA  
Weather : Clear

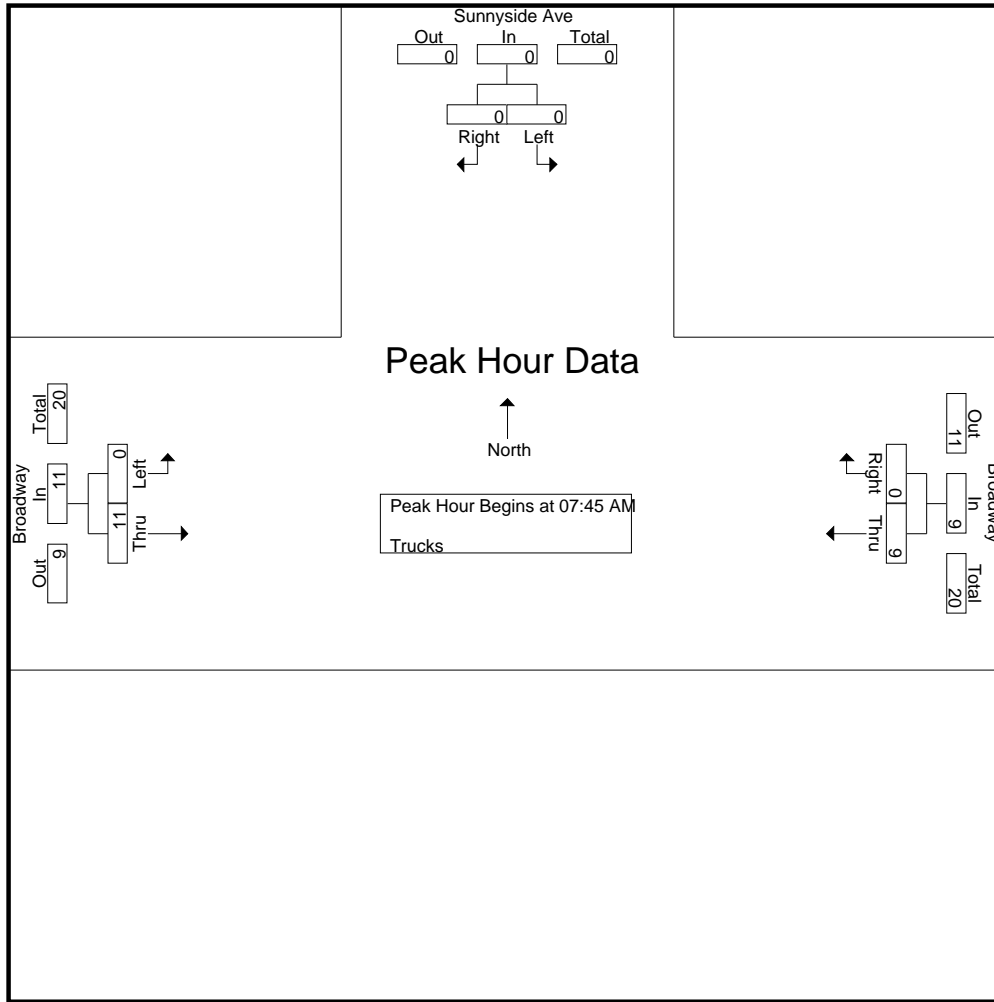

Peak Hour Analysis From 07:00 AM to 08:45 AM - Peak 1 of 1  
Peak Hour for Each Approach Begins at:

	07:00 AM			07:15 AM			07:45 AM		
+0 mins.	0	0	0	4	0	4	0	2	2
+15 mins.	0	0	0	1	0	1	0	2	2
+30 mins.	0	0	0	2	0	2	0	3	3
+45 mins.	0	0	0	3	0	3	0	4	4
Total Volume	0	0	0	10	0	10	0	11	11
% App. Total	0	0	0	100	0	100	0	100	100
PHF	.000	.000	.000	.625	.000	.625	.000	.688	.688

N/S Street : Sunnyside Avenue  
E/W Street : Broadway  
City/State : Arlington, MA  
Weather : Clear

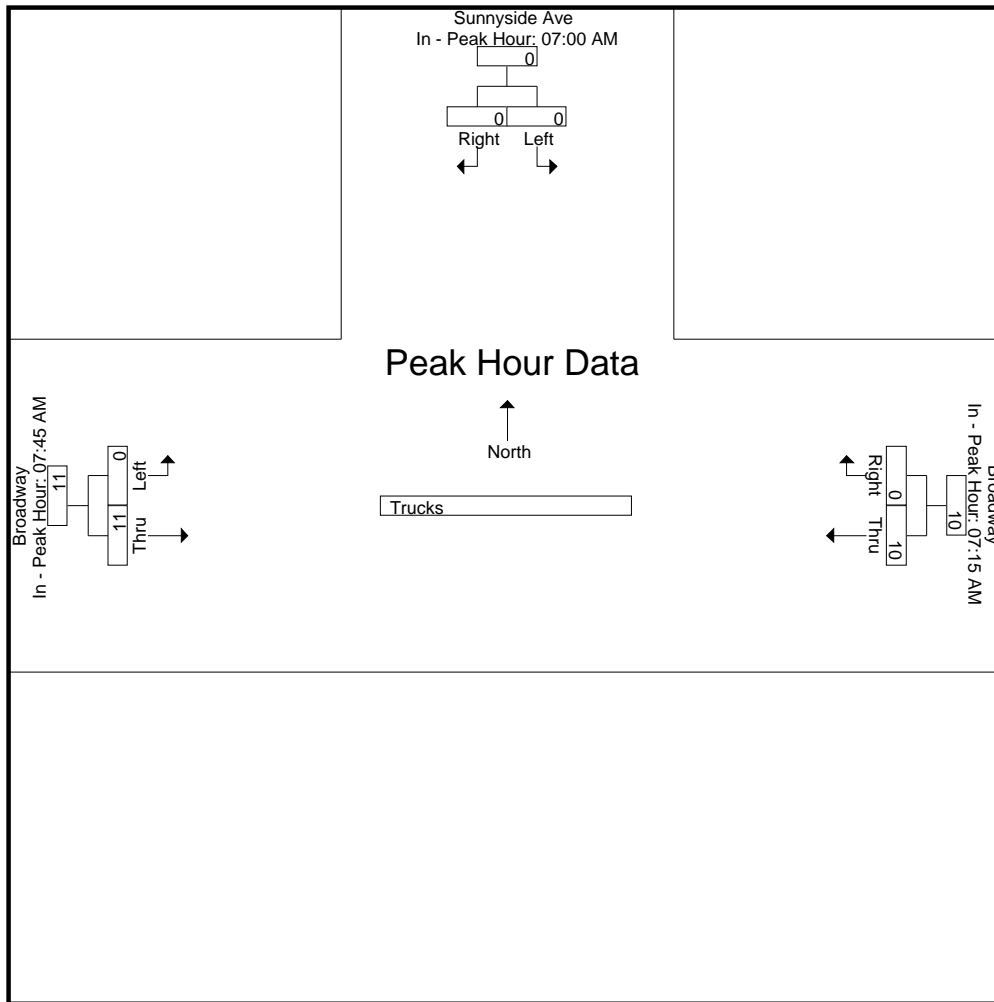

**Accurate Counts**  
978-664-2565

N/S Street : Sunnyside Avenue  
E/W Street : Broadway  
City/State : Arlington, MA  
Weather : Clear

File Name : 15289002  
Site Code : 15289002  
Start Date : 11/3/2022  
Page No : 10

Groups Printed- Bikes Peds

Start Time	Sunnyside Ave From North			Broadway From East			Broadway From West			Exclu. Total	Inclu. Total	Int. Total
	Left	Right	Peds	Thru	Right	Peds	Left	Thru	Peds			
07:00 AM	0	0	1	1	1	3	0	1	0	4	3	7
07:15 AM	0	0	4	1	0	0	0	0	0	4	1	5
07:30 AM	2	0	1	1	0	0	0	4	0	1	7	8
07:45 AM	1	0	2	3	0	0	0	6	2	4	10	14
<b>Total</b>	<b>3</b>	<b>0</b>	<b>8</b>	<b>6</b>	<b>1</b>	<b>3</b>	<b>0</b>	<b>11</b>	<b>2</b>	<b>13</b>	<b>21</b>	<b>34</b>
08:00 AM	0	0	4	1	0	1	1	5	0	5	7	12
08:15 AM	0	0	4	3	0	2	0	2	1	7	5	12
08:30 AM	0	0	2	0	0	1	0	0	0	3	0	3
08:45 AM	0	0	5	3	0	1	0	4	0	6	7	13
<b>Total</b>	<b>0</b>	<b>0</b>	<b>15</b>	<b>7</b>	<b>0</b>	<b>5</b>	<b>1</b>	<b>11</b>	<b>1</b>	<b>21</b>	<b>19</b>	<b>40</b>
<b>Grand Total</b>	<b>3</b>	<b>0</b>	<b>23</b>	<b>13</b>	<b>1</b>	<b>8</b>	<b>1</b>	<b>22</b>	<b>3</b>	<b>34</b>	<b>40</b>	<b>74</b>
Apprch %	100	0		92.9	7.1		4.3	95.7				
Total %	7.5	0		32.5	2.5		2.5	55		45.9	54.1	

Start Time	Sunnyside Ave From North			Broadway From East			Broadway From West			Int. Total
	Left	Right	App. Total	Thru	Right	App. Total	Left	Thru	App. Total	
Peak Hour Analysis From 07:00 AM to 08:45 AM - Peak 1 of 1										
Peak Hour for Entire Intersection Begins at 07:30 AM										
07:30 AM	<b>2</b>	0	<b>2</b>	1	0	1	0	4	4	7
07:45 AM	1	0	1	<b>3</b>	0	<b>3</b>	0	<b>6</b>	<b>6</b>	<b>10</b>
08:00 AM	0	0	0	1	0	1	1	5	6	7
08:15 AM	0	0	0	3	0	3	0	2	2	5
<b>Total Volume</b>	<b>3</b>	<b>0</b>	<b>3</b>	<b>8</b>	<b>0</b>	<b>8</b>	<b>1</b>	<b>17</b>	<b>18</b>	<b>29</b>
<b>% App. Total</b>	<b>100</b>	<b>0</b>	<b>100</b>	<b>100</b>	<b>0</b>	<b>100</b>	<b>5.6</b>	<b>94.4</b>		
PHF	.375	.000	.375	.667	.000	.667	.250	.708	.750	.725

N/S Street : Sunnyside Avenue  
E/W Street : Broadway  
City/State : Arlington, MA  
Weather : Clear

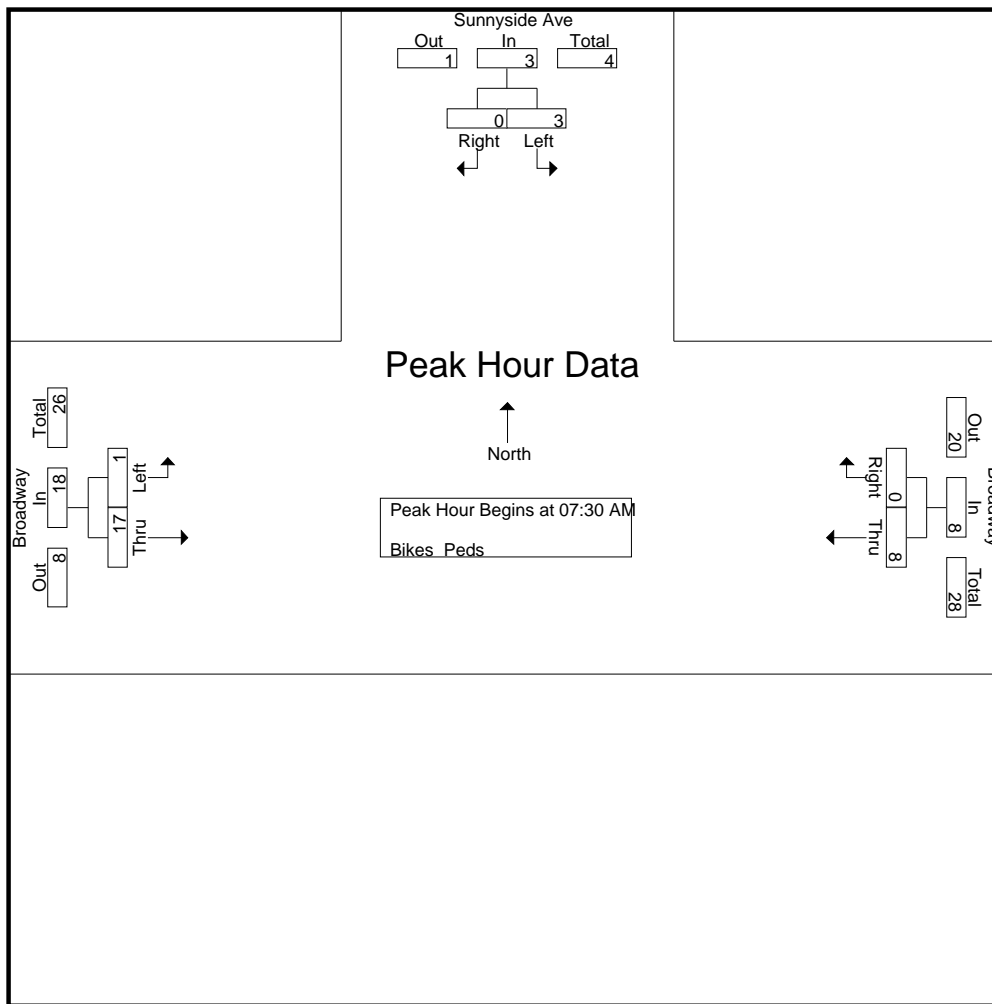

Peak Hour Analysis From 07:00 AM to 08:45 AM - Peak 1 of 1  
Peak Hour for Each Approach Begins at:

	07:00 AM			07:30 AM			07:30 AM		
+0 mins.	0	0	0	1	0	1	0	4	4
+15 mins.	0	0	0	3	0	3	0	6	6
+30 mins.	2	0	2	1	0	1	1	5	6
+45 mins.	1	0	1	3	0	3	0	2	2
Total Volume	3	0	3	8	0	8	1	17	18
% App. Total	100	0		100	0		5.6	94.4	
PHF	.375	.000	.375	.667	.000	.667	.250	.708	.750

N/S Street : Sunnyside Avenue  
E/W Street : Broadway  
City/State : Arlington, MA  
Weather : Clear

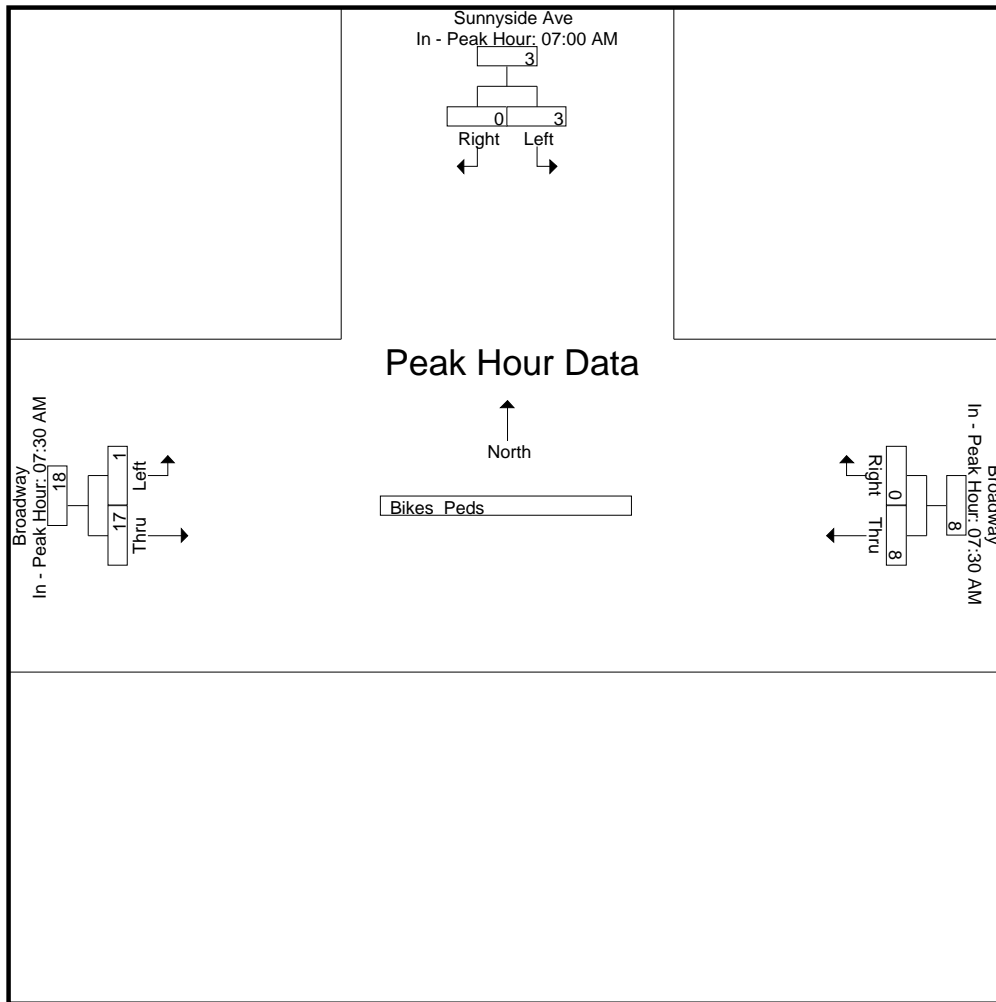

# Accurate Counts

978-664-2565

N/S Street : Sunnyside Avenue  
 E/W Street : Broadway  
 City/State : Arlington, MA  
 Weather : Clear

File Name : 15289002  
 Site Code : 15289002  
 Start Date : 11/3/2022  
 Page No : 1

### Groups Printed- Cars - Trucks

Start Time	Sunnyside Ave From North		Broadway From East		Broadway From West		Int. Total
	Left	Right	Thru	Right	Left	Thru	
04:00 PM	1	2	71	1	1	95	171
04:15 PM	7	3	57	4	8	94	173
04:30 PM	2	5	84	2	5	106	204
04:45 PM	4	3	69	6	1	108	191
<b>Total</b>	<b>14</b>	<b>13</b>	<b>281</b>	<b>13</b>	<b>15</b>	<b>403</b>	<b>739</b>
05:00 PM	8	1	86	2	1	98	196
05:15 PM	4	6	81	5	0	125	221
05:30 PM	3	4	89	7	3	115	221
05:45 PM	3	4	102	3	1	97	210
<b>Total</b>	<b>18</b>	<b>15</b>	<b>358</b>	<b>17</b>	<b>5</b>	<b>435</b>	<b>848</b>
<b>Grand Total</b>	<b>32</b>	<b>28</b>	<b>639</b>	<b>30</b>	<b>20</b>	<b>838</b>	<b>1587</b>
Apprch %	53.3	46.7	95.5	4.5	2.3	97.7	
Total %	2	1.8	40.3	1.9	1.3	52.8	
Cars	32	28	627	30	20	828	1565
% Cars	100	100	98.1	100	100	98.8	98.6
Trucks	0	0	12	0	0	10	22
% Trucks	0	0	1.9	0	0	1.2	1.4

Start Time	Sunnyside Ave From North			Broadway From East			Broadway From West			Int. Total
	Left	Right	App. Total	Thru	Right	App. Total	Left	Thru	App. Total	
<b>Peak Hour Analysis From 04:00 PM to 05:45 PM - Peak 1 of 1</b>										
<b>Peak Hour for Entire Intersection Begins at 05:00 PM</b>										
05:00 PM	<b>8</b>	1	9	86	2	88	1	98	99	196
05:15 PM	4	<b>6</b>	<b>10</b>	81	5	86	0	<b>125</b>	<b>125</b>	<b>221</b>
05:30 PM	3	4	7	89	<b>7</b>	96	<b>3</b>	115	118	221
05:45 PM	3	4	7	<b>102</b>	3	<b>105</b>	1	97	98	210
<b>Total Volume</b>	<b>18</b>	<b>15</b>	<b>33</b>	<b>358</b>	<b>17</b>	<b>375</b>	<b>5</b>	<b>435</b>	<b>440</b>	<b>848</b>
% App. Total	54.5	45.5		95.5	4.5		1.1	98.9		
PHF	.563	.625	.825	.877	.607	.893	.417	.870	.880	.959
Cars	18	15	33	352	17	369	5	430	435	837
% Cars	100	100	100	98.3	100	98.4	100	98.9	98.9	98.7
Trucks	0	0	0	6	0	6	0	5	5	11
% Trucks	0	0	0	1.7	0	1.6	0	1.1	1.1	1.3

N/S Street : Sunnyside Avenue  
E/W Street : Broadway  
City/State : Arlington, MA  
Weather : Clear

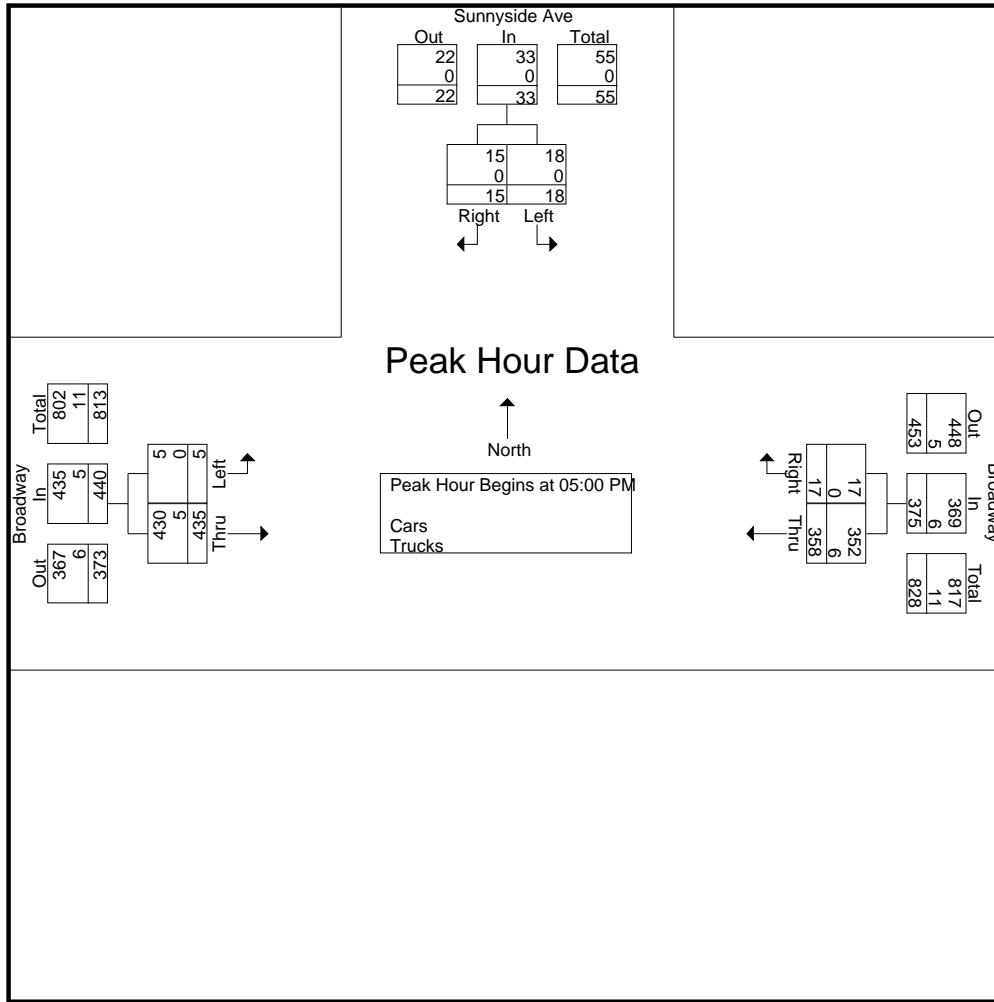

Peak Hour Analysis From 04:00 PM to 05:45 PM - Peak 1 of 1  
Peak Hour for Each Approach Begins at:

	04:15 PM			05:00 PM			04:45 PM		
+0 mins.	7	3	<b>10</b>	86	2	88	1	108	109
+15 mins.	2	<b>5</b>	7	81	5	86	1	98	99
+30 mins.	4	3	7	89	<b>7</b>	96	0	<b>125</b>	<b>125</b>
+45 mins.	<b>8</b>	1	9	<b>102</b>	3	<b>105</b>	<b>3</b>	115	118
Total Volume	21	12	33	358	17	375	5	446	451
% App. Total	63.6	36.4		95.5	4.5		1.1	98.9	
PHF	.656	.600	.825	.877	.607	.893	.417	.892	.902
Cars	21	12	33	352	17	369	5	441	446
% Cars	100	100	100	98.3	100	98.4	100	98.9	98.9
Trucks	0	0	0	6	0	6	0	5	5
% Trucks	0	0	0	1.7	0	1.6	0	1.1	1.1



N/S Street : Sunnyside Avenue  
E/W Street : Broadway  
City/State : Arlington, MA  
Weather : Clear

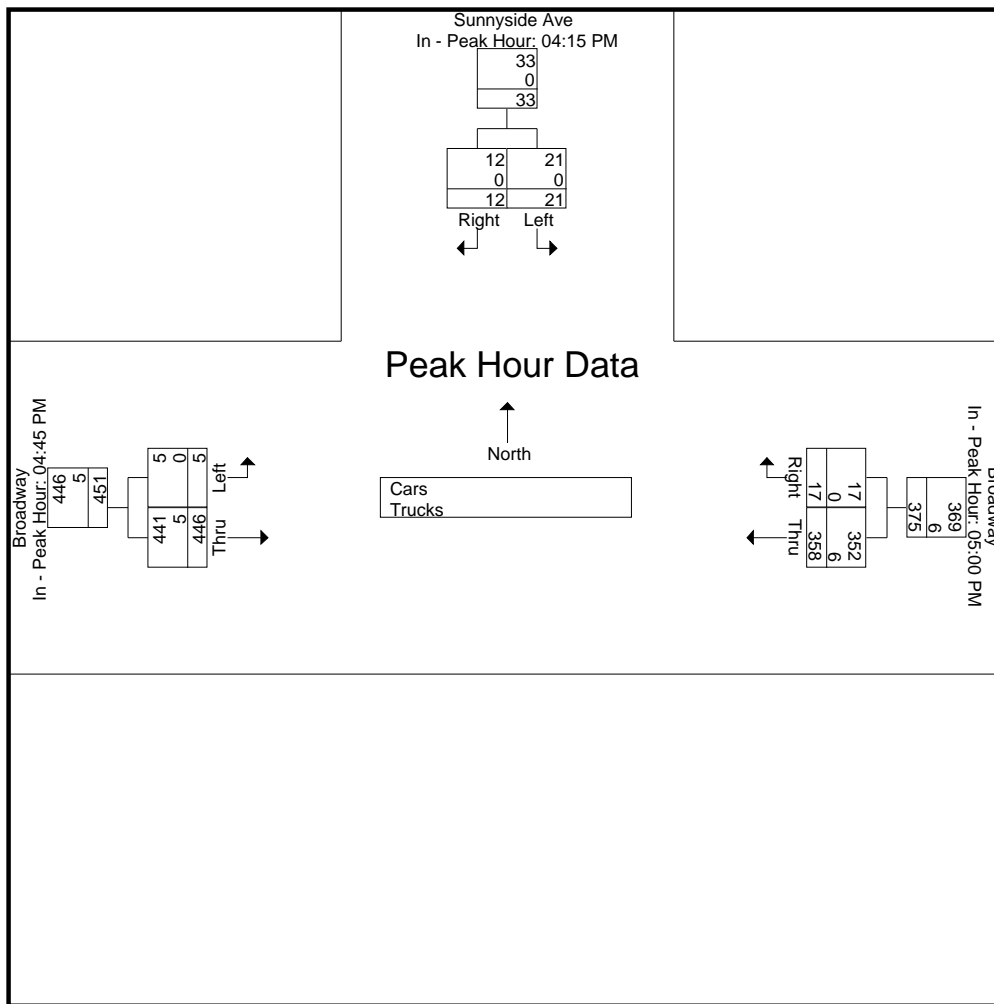

**Accurate Counts**  
978-664-2565

File Name : 15289002  
Site Code : 15289002  
Start Date : 11/3/2022  
Page No : 4

N/S Street : Sunnyside Avenue  
E/W Street : Broadway  
City/State : Arlington, MA  
Weather : Clear

Groups Printed- Cars

Start Time	Sunnyside Ave From North		Broadway From East		Broadway From West		Int. Total
	Left	Right	Thru	Right	Left	Thru	
04:00 PM	1	2	69	1	1	94	168
04:15 PM	7	3	56	4	8	93	171
04:30 PM	2	5	82	2	5	103	199
04:45 PM	4	3	68	6	1	108	190
<b>Total</b>	<b>14</b>	<b>13</b>	<b>275</b>	<b>13</b>	<b>15</b>	<b>398</b>	<b>728</b>
05:00 PM	8	1	84	2	1	96	192
05:15 PM	4	6	80	5	0	123	218
05:30 PM	3	4	88	7	3	114	219
05:45 PM	3	4	100	3	1	97	208
<b>Total</b>	<b>18</b>	<b>15</b>	<b>352</b>	<b>17</b>	<b>5</b>	<b>430</b>	<b>837</b>
<b>Grand Total</b>	<b>32</b>	<b>28</b>	<b>627</b>	<b>30</b>	<b>20</b>	<b>828</b>	<b>1565</b>
Apprch %	53.3	46.7	95.4	4.6	2.4	97.6	
Total %	2	1.8	40.1	1.9	1.3	52.9	

Start Time	Sunnyside Ave From North			Broadway From East			Broadway From West			Int. Total
	Left	Right	App. Total	Thru	Right	App. Total	Left	Thru	App. Total	
Peak Hour Analysis From 04:00 PM to 05:45 PM - Peak 1 of 1										
Peak Hour for Entire Intersection Begins at 05:00 PM										
05:00 PM	<b>8</b>	<b>1</b>	<b>9</b>	84	2	86	1	96	97	192
05:15 PM	4	<b>6</b>	<b>10</b>	80	5	85	0	<b>123</b>	<b>123</b>	218
05:30 PM	3	4	7	88	<b>7</b>	95	<b>3</b>	114	117	<b>219</b>
05:45 PM	3	4	7	<b>100</b>	3	<b>103</b>	1	97	98	208
Total Volume	18	15	33	352	17	369	5	430	435	837
% App. Total	54.5	45.5		95.4	4.6		1.1	98.9		
PHF	.563	.625	.825	.880	.607	.896	.417	.874	.884	.955

**Accurate Counts**  
978-664-2565

File Name : 15289002  
Site Code : 15289002  
Start Date : 11/3/2022  
Page No : 5

N/S Street : Sunnyside Avenue  
E/W Street : Broadway  
City/State : Arlington, MA  
Weather : Clear

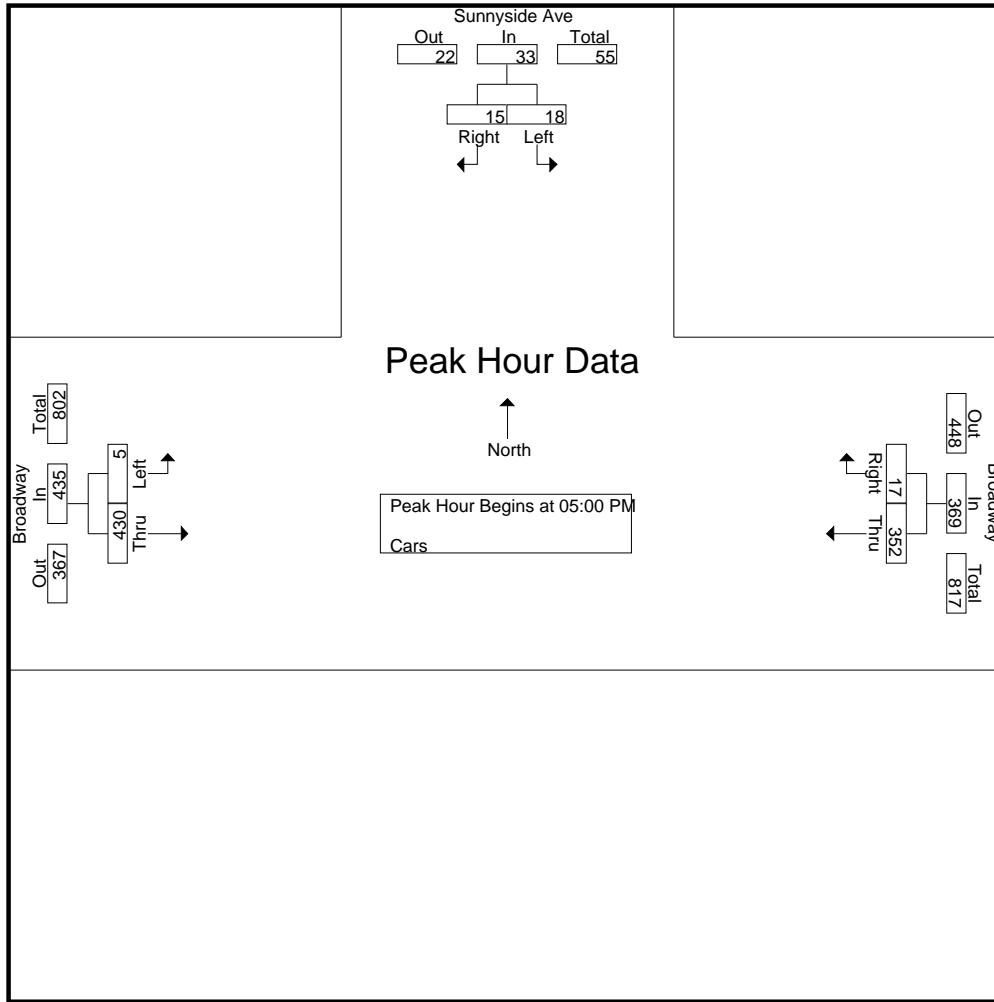

Peak Hour Analysis From 04:00 PM to 05:45 PM - Peak 1 of 1  
Peak Hour for Each Approach Begins at:

	04:15 PM			05:00 PM			04:45 PM		
+0 mins.	7	3	<b>10</b>	84	2	86	1	108	109
+15 mins.	2	<b>5</b>	7	80	5	85	1	96	97
+30 mins.	4	3	7	88	<b>7</b>	95	0	<b>123</b>	<b>123</b>
+45 mins.	<b>8</b>	1	9	<b>100</b>	3	<b>103</b>	<b>3</b>	114	117
Total Volume	21	12	33	352	17	369	5	441	446
% App. Total	63.6	36.4		95.4	4.6		1.1	98.9	
PHF	.656	.600	.825	.880	.607	.896	.417	.896	.907

N/S Street : Sunnyside Avenue  
E/W Street : Broadway  
City/State : Arlington, MA  
Weather : Clear

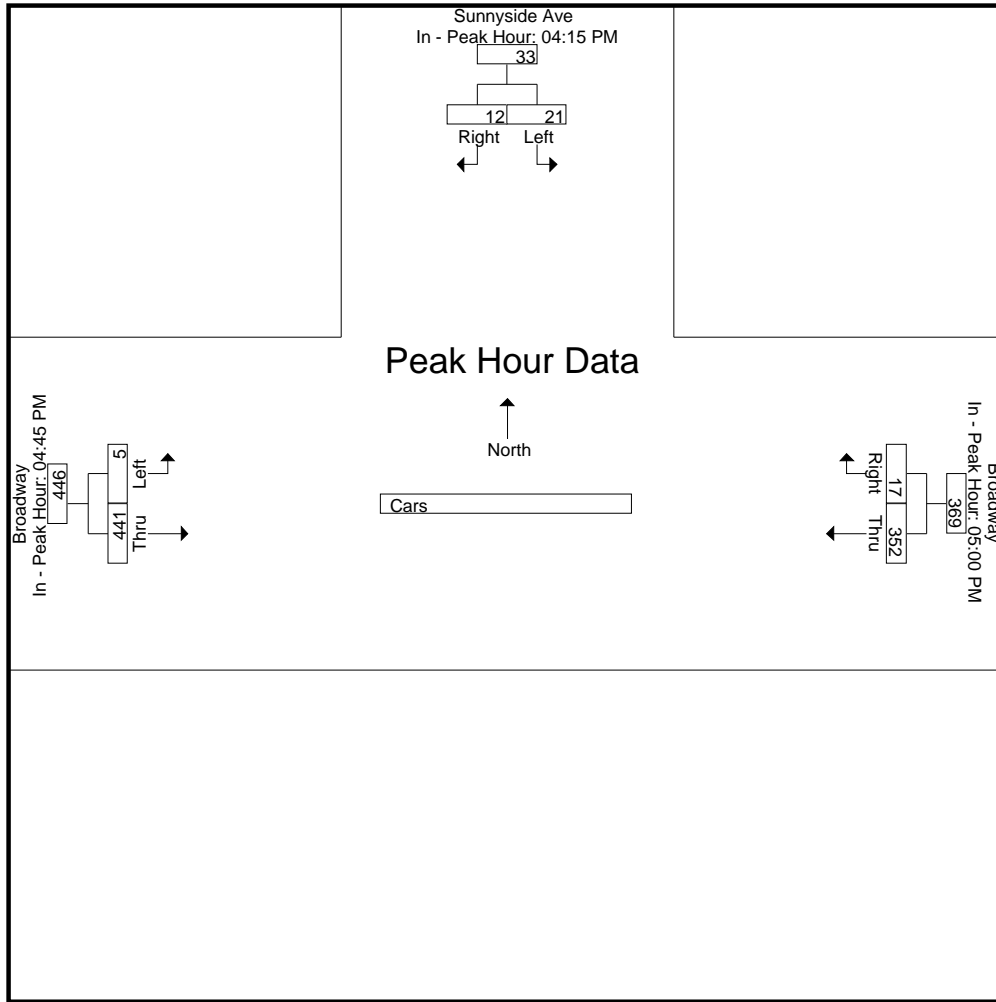

**Accurate Counts**  
978-664-2565

N/S Street : Sunnyside Avenue  
E/W Street : Broadway  
City/State : Arlington, MA  
Weather : Clear

File Name : 15289002  
Site Code : 15289002  
Start Date : 11/3/2022  
Page No : 7

Groups Printed- Trucks

Start Time	Sunnyside Ave From North		Broadway From East		Broadway From West		Int. Total
	Left	Right	Thru	Right	Left	Thru	
04:00 PM	0	0	2	0	0	1	3
04:15 PM	0	0	1	0	0	1	2
04:30 PM	0	0	2	0	0	3	5
04:45 PM	0	0	1	0	0	0	1
Total	0	0	6	0	0	5	11
05:00 PM	0	0	2	0	0	2	4
05:15 PM	0	0	1	0	0	2	3
05:30 PM	0	0	1	0	0	1	2
05:45 PM	0	0	2	0	0	0	2
Total	0	0	6	0	0	5	11
Grand Total	0	0	12	0	0	10	22
Apprch %	0	0	100	0	0	100	
Total %	0	0	54.5	0	0	45.5	

Start Time	Sunnyside Ave From North			Broadway From East			Broadway From West			Int. Total
	Left	Right	App. Total	Thru	Right	App. Total	Left	Thru	App. Total	
Peak Hour Analysis From 04:00 PM to 05:45 PM - Peak 1 of 1										
Peak Hour for Entire Intersection Begins at 04:30 PM										
04:30 PM	0	0	0	2	0	2	0	3	3	5
04:45 PM	0	0	0	1	0	1	0	0	0	1
05:00 PM	0	0	0	2	0	2	0	2	2	4
05:15 PM	0	0	0	1	0	1	0	2	2	3
Total Volume	0	0	0	6	0	6	0	7	7	13
% App. Total	0	0	0	100	0	100	0	100	0	
PHF	.000	.000	.000	.750	.000	.750	.000	.583	.583	.650

N/S Street : Sunnyside Avenue  
E/W Street : Broadway  
City/State : Arlington, MA  
Weather : Clear

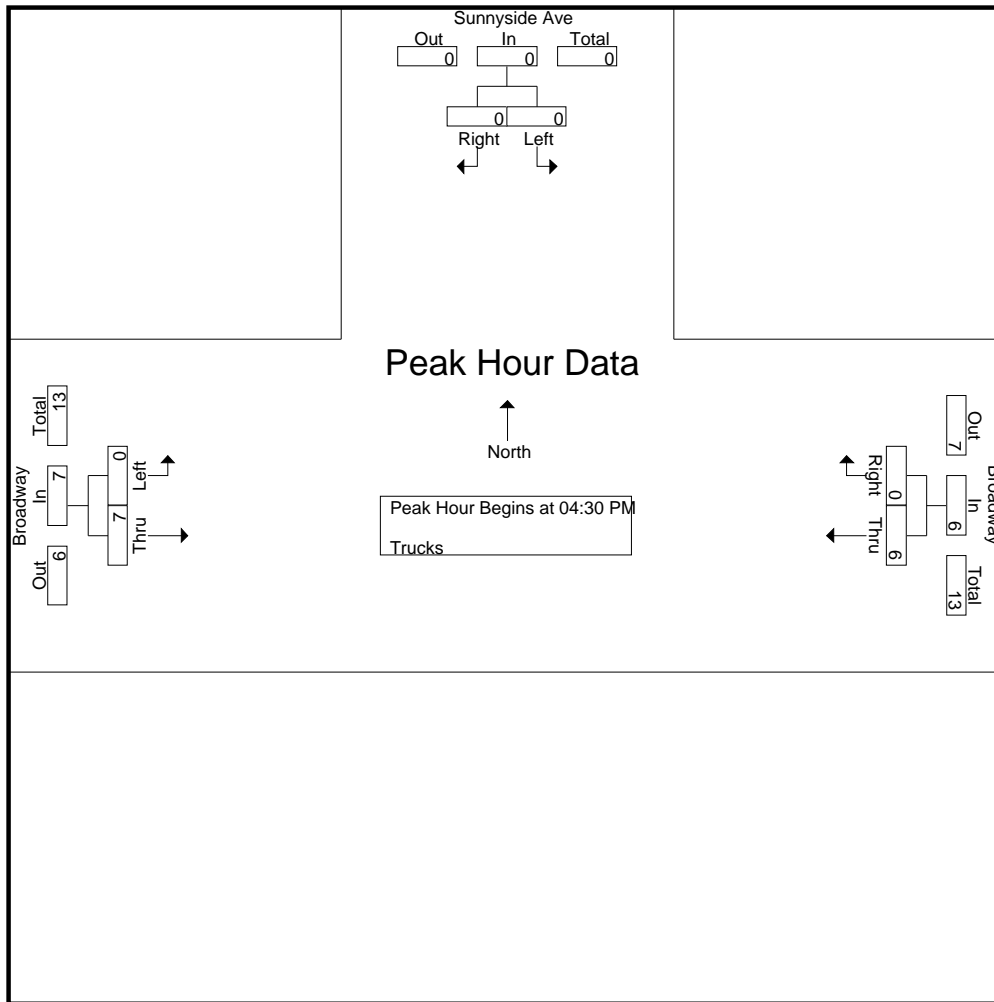

Peak Hour Analysis From 04:00 PM to 05:45 PM - Peak 1 of 1  
Peak Hour for Each Approach Begins at:

	04:00 PM			04:00 PM			04:30 PM		
+0 mins.	0	0	0	<b>2</b>	0	<b>2</b>	0	<b>3</b>	<b>3</b>
+15 mins.	0	0	0	1	0	1	0	0	0
+30 mins.	0	0	0	2	0	2	0	2	2
+45 mins.	0	0	0	1	0	1	0	2	2
Total Volume	0	0	0	6	0	6	0	7	7
% App. Total	0	0	0	100	0	100	0	100	100
PHF	.000	.000	.000	.750	.000	.750	.000	.583	.583

N/S Street : Sunnyside Avenue  
E/W Street : Broadway  
City/State : Arlington, MA  
Weather : Clear

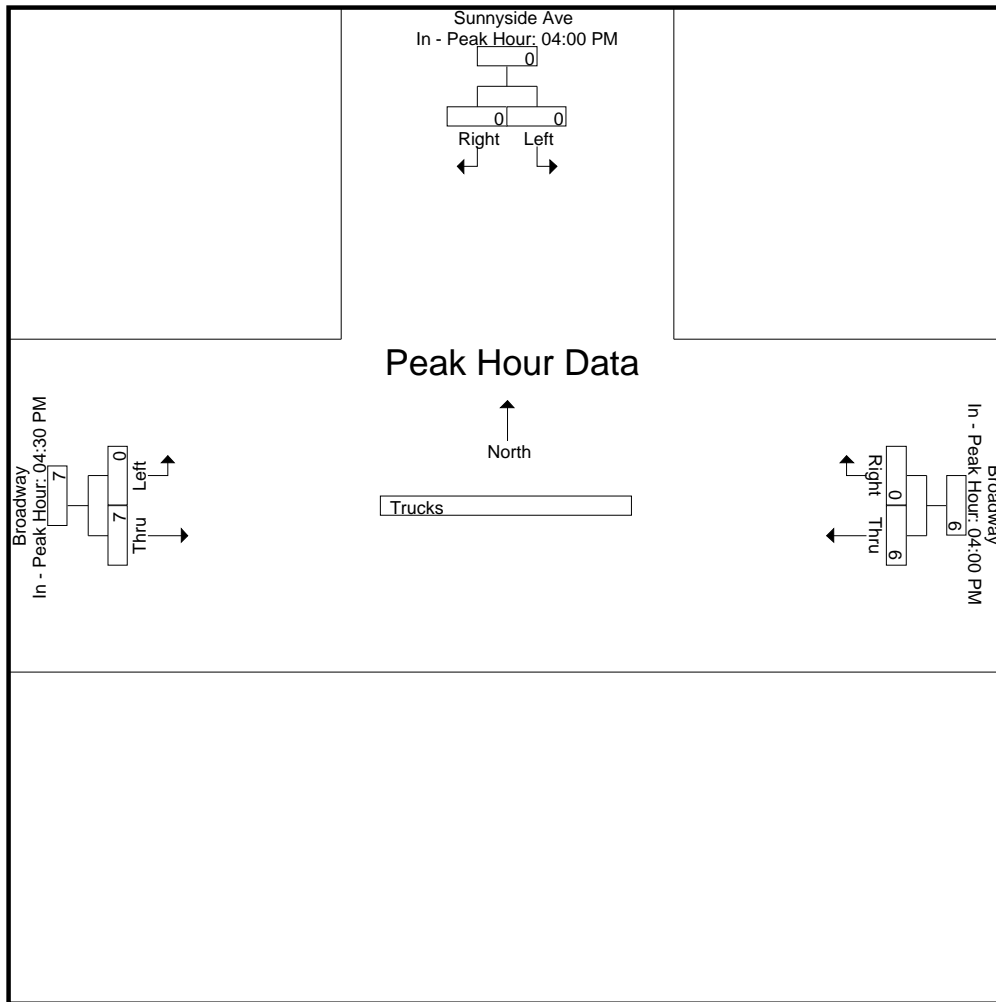



**Accurate Counts**  
978-664-2565

N/S Street : Sunnyside Avenue  
E/W Street : Broadway  
City/State : Arlington, MA  
Weather : Clear

File Name : 15289002  
Site Code : 15289002  
Start Date : 11/3/2022  
Page No : 10

Groups Printed- Bikes Peds

Start Time	Sunnyside Ave From North			Broadway From East			Broadway From West			Exclu. Total	Inclu. Total	Int. Total
	Left	Right	Peds	Thru	Right	Peds	Left	Thru	Peds			
04:00 PM	0	0	10	4	0	2	1	3	0	12	8	20
04:15 PM	0	0	12	3	0	0	0	2	0	12	5	17
04:30 PM	0	0	9	4	0	0	0	3	3	12	7	19
04:45 PM	0	0	9	3	0	1	0	2	0	10	5	15
<b>Total</b>	<b>0</b>	<b>0</b>	<b>40</b>	<b>14</b>	<b>0</b>	<b>3</b>	<b>1</b>	<b>10</b>	<b>3</b>	<b>46</b>	<b>25</b>	<b>71</b>
05:00 PM	0	0	5	1	0	0	0	6	0	5	7	12
05:15 PM	0	0	3	4	0	1	0	2	0	4	6	10
05:30 PM	0	0	4	1	0	3	1	3	0	7	5	12
05:45 PM	0	0	8	2	0	0	0	1	0	8	3	11
<b>Total</b>	<b>0</b>	<b>0</b>	<b>20</b>	<b>8</b>	<b>0</b>	<b>4</b>	<b>1</b>	<b>12</b>	<b>0</b>	<b>24</b>	<b>21</b>	<b>45</b>
<b>Grand Total</b>	<b>0</b>	<b>0</b>	<b>60</b>	<b>22</b>	<b>0</b>	<b>7</b>	<b>2</b>	<b>22</b>	<b>3</b>	<b>70</b>	<b>46</b>	<b>116</b>
Apprch %	0	0		100	0		8.3	91.7				
Total %	0	0		47.8	0		4.3	47.8		60.3	39.7	

Start Time	Sunnyside Ave From North			Broadway From East			Broadway From West			Int. Total
	Left	Right	App. Total	Thru	Right	App. Total	Left	Thru	App. Total	
Peak Hour Analysis From 04:00 PM to 05:45 PM - Peak 1 of 1										
Peak Hour for Entire Intersection Begins at 04:00 PM										
04:00 PM	0	0	0	4	0	4	1	3	4	8
04:15 PM	0	0	0	3	0	3	0	2	2	5
04:30 PM	0	0	0	4	0	4	0	3	3	7
04:45 PM	0	0	0	3	0	3	0	2	2	5
<b>Total Volume</b>	<b>0</b>	<b>0</b>	<b>0</b>	<b>14</b>	<b>0</b>	<b>14</b>	<b>1</b>	<b>10</b>	<b>11</b>	<b>25</b>
<b>% App. Total</b>	<b>0</b>	<b>0</b>	<b>0</b>	<b>100</b>	<b>0</b>	<b>100</b>	<b>9.1</b>	<b>90.9</b>		
PHF	.000	.000	.000	.875	.000	.875	.250	.833	.688	.781

N/S Street : Sunnyside Avenue  
E/W Street : Broadway  
City/State : Arlington, MA  
Weather : Clear

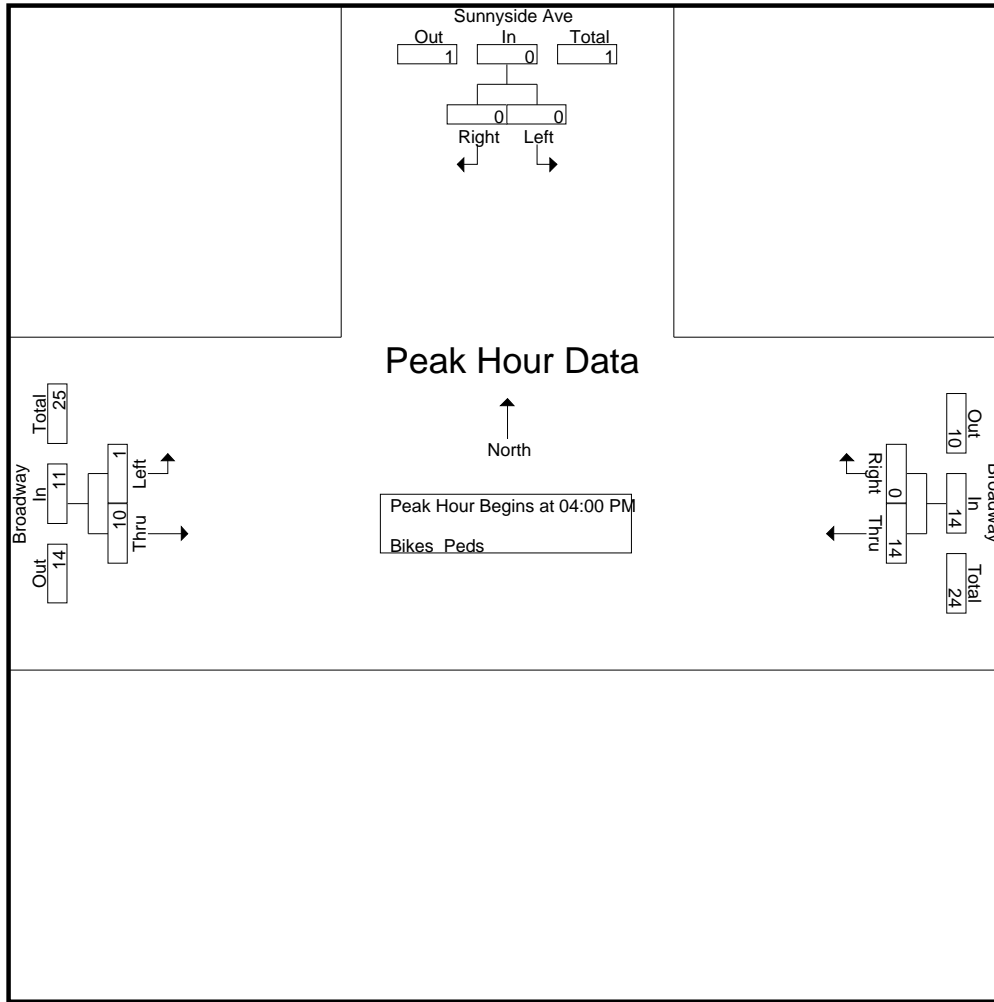

Peak Hour Analysis From 04:00 PM to 05:45 PM - Peak 1 of 1  
Peak Hour for Each Approach Begins at:

	04:00 PM			04:00 PM			04:45 PM		
+0 mins.	0	0	0	4	0	4	0	2	2
+15 mins.	0	0	0	3	0	3	0	6	6
+30 mins.	0	0	0	4	0	4	0	2	2
+45 mins.	0	0	0	3	0	3	1	3	4
Total Volume	0	0	0	14	0	14	1	13	14
% App. Total	0	0		100	0		7.1	92.9	
PHF	.000	.000	.000	.875	.000	.875	.250	.542	.583

N/S Street : Sunnyside Avenue  
E/W Street : Broadway  
City/State : Arlington, MA  
Weather : Clear

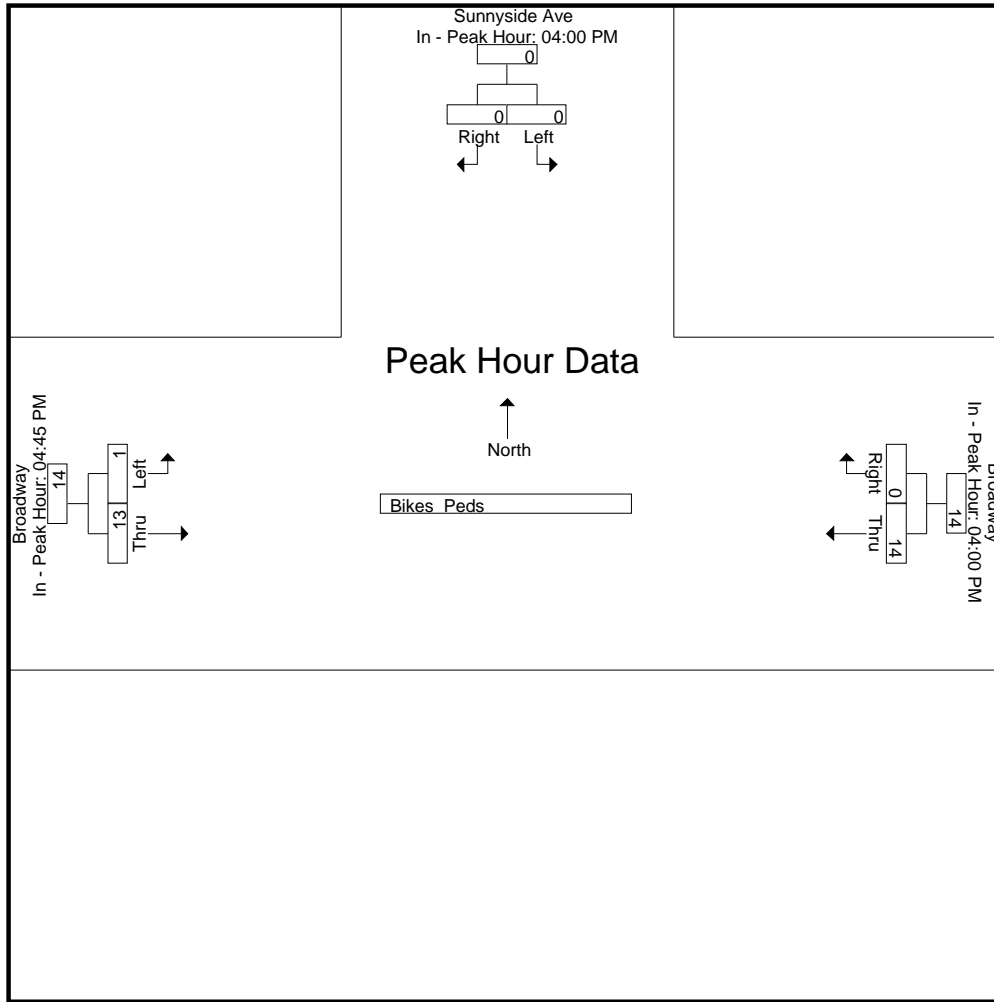



Appendix B: MassDOT's 2019 Weekday Seasonal Adjustment Factors

Massachusetts Highway Department  
Statewide Traffic Data Collection  
2019 Weekday Seasonal Factors

Factor Group	JAN	FEB	MAR	APR	MAY	JUN	JUL	AUG	SEP	OCT	NOV	DEC	Axle Factor
R1	1.22	1.14	1.12	1.06	1.00	0.96	0.87	0.85	0.96	0.99	1.04	1.12	0.85
R2	0.95	0.96	0.98	0.97	0.97	0.93	0.97	0.94	0.96	0.90	0.92	0.93	0.96
R3	1.15	1.06	1.07	1.00	0.89	0.88	0.89	0.89	0.95	0.92	1.02	1.01	0.97
R4-R7	1.09	1.09	1.11	1.02	0.96	0.92	0.89	0.89	0.99	0.98	1.09	1.13	0.98
U1-Boston	1.03	1.01	0.98	0.94	0.94	0.92	0.95	0.93	0.94	0.94	0.97	1.04	0.96
U1-Essex	1.09	1.06	1.03	0.99	0.94	0.90	0.88	0.86	0.93	0.94	0.99	1.06	0.93
U1-Southeast	1.06	1.05	1.01	0.97	0.95	0.93	0.93	0.90	0.94	0.94	0.98	1.04	0.98
U1-West	1.19	1.14	1.09	0.95	0.92	0.89	0.89	0.86	0.91	0.95	0.97	1.07	0.84
U1-Worcester	1.02	1.04	0.97	0.94	0.93	0.91	0.95	0.91	0.93	0.92	0.95	1.10	0.88
U2	1.01	1.00	0.94	0.93	0.91	0.89	0.93	0.90	0.90	0.91	0.94	1.02	0.99
U3	1.06	1.03	0.98	0.94	0.93	0.91	0.95	0.91	0.92	0.93	0.97	1.00	0.98
U4-U7	1.01	1.00	0.95	0.92	0.88	0.86	0.92	0.91	0.92	0.94	0.99	1.04	0.99
Rec - East	1.04	1.16	1.12	0.98	0.92	0.88	0.77	0.81	0.94	1.02	1.08	1.12	0.99
Rec - West	1.30	1.23	1.32	1.18	0.95	0.82	0.70	0.69	0.97	0.96	1.16	1.15	0.98

Round off:

0-999 = 10

>1000 = 100

U = Urban

R = Rural

1 - Interstate

2 - Freeway and Expressway

3 - Other Principal Arterial

4 - Minor Arterial

5 - Major Collector

6 - Minor Collector

7 - Local Road and Street

**Recreational - East Group** - Cape Cod (all towns) including the town of Plymouth south of Route 3A (stations 7014,7079,7080,7090,7091,7092,7093,7094,7095,7096,7097,7108 and 7178), Martha's Vineyard and Nantucket.

**Recreational - West Group** - Continuous Stations 2 and 189 including stations 1066,1067,1083,1084,1085,1086,1087,1088,1089,1090,1091,1092,1093,1094,1095,1096,1097,1098,1099,1100,1101,1102,1103,1104,1105,1106,1107,1108,1113,1114,1116,2196,2197 and 2198.



Appendix C: Crash Rate Worksheets

## INTERSECTION CRASH RATE WORKSHEET

CITY/TOWN : ARLINGTON/SOMERVILLE      COUNT DATE : 11/3/2022

DISTRICT : 4      UNSIGNALIZED :       SIGNALIZED :

~ INTERSECTION DATA ~

MAJOR STREET : ALEWIFE BROOK PARKWAY

MINOR STREET(S) : BROADWAY

**INTERSECTION  
DIAGRAM**

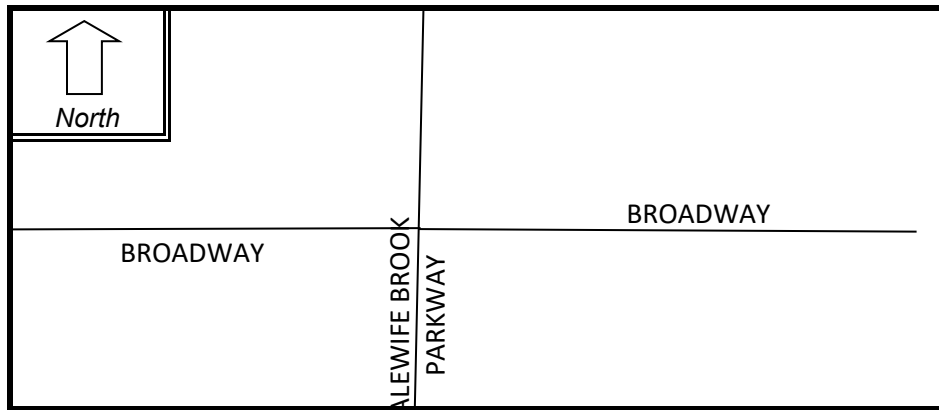

**PEAK HOUR VOLUMES**

APPROACH :	1	2	3	4	5	Total Peak Hourly Approach Volume
DIRECTION :	EB	WB	NB	SB		
PEAK HOURLY VOLUMES (AM/PM) :	322	456	859	895		2,532

" K " FACTOR :       INTERSECTION ADT ( V ) = TOTAL DAILY APPROACH VOLUME :

TOTAL # OF CRASHES :       # OF YEARS :       AVERAGE # OF CRASHES PER YEAR ( A ) :

**CRASH RATE CALCULATION :**            RATE =  $\frac{( A * 1,000,000 )}{( V * 365 )}$

Comments : PM Peak used

Project Title & Date: HCA 10 SUNNYSIDE AVENUE

# INTERSECTION CRASH RATE WORKSHEET

CITY/TOWN : ARLINGTON COUNT DATE : 11/3/2022

DISTRICT : 4 UNSIGNALIZED :  SIGNALIZED :

~ INTERSECTION DATA ~

MAJOR STREET : BROADWAY

MINOR STREET(S) : SUNNYSIDE AVENUE

INTERSECTION  
DIAGRAM

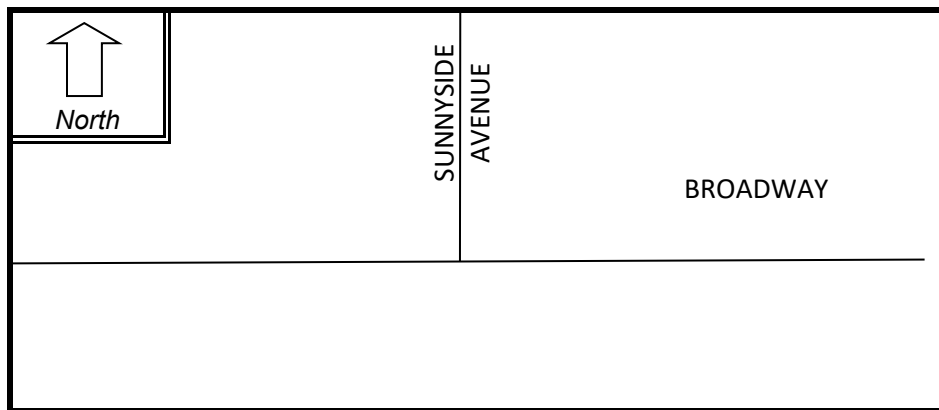

**PEAK HOUR VOLUMES**

APPROACH :	1	2	3	4	5	Total Peak Hourly Approach Volume
DIRECTION :	EB	WB	NB	SB		
PEAK HOURLY VOLUMES (AM/PM) :	440	375		33		<b>848</b>

" K " FACTOR :  INTERSECTION ADT ( V ) = TOTAL DAILY APPROACH VOLUME :

TOTAL # OF CRASHES :  # OF YEARS :  AVERAGE # OF CRASHES PER YEAR ( A ) :

**CRASH RATE CALCULATION :**  RATE = 
$$\frac{(A * 1,000,000)}{(V * 365)}$$

Comments : PM Peak used

Project Title & Date: HCA 10 SUNNYSIDE AVENUE





















Appendix D: Capacity Analysis

1: Alewife Brook Pkwy & Broadway  
Lanes, Volumes, Timings

11/18/2022

												
Lane Group	EBL	EBT	EBR	WBL	WBT	WBR	NBL	NBT	NBR	SBL	SBT	SBR
Lane Configurations												
Traffic Volume (vph)	112	161	11	132	224	48	20	974	77	17	359	74
Future Volume (vph)	112	161	11	132	224	48	20	974	77	17	359	74
Ideal Flow (vphpl)	1900	1900	1900	1900	1900	1900	1900	1900	1900	1900	1900	1900
Lane Width (ft)	11	11	11	11	11	11	10	10	10	10	10	10
Grade (%)		0%			0%			1%			1%	
Storage Length (ft)	0		0	0		175	0		0	0		0
Storage Lanes	0		0	0		1	0		0	0		0
Taper Length (ft)	25			25			25			25		
Lane Util. Factor	0.95	0.95	0.95	0.95	0.95	0.95	0.95	0.95	0.95	0.95	0.95	0.95
Ped Bike Factor		1.00			1.00			1.00			1.00	
Fr <sub>t</sub>		0.992			0.983			0.987			0.976	
Fl <sub>t</sub> Protected		0.982			0.983			0.999			0.998	
Satd. Flow (prot)	0	3227	0	0	3329	0	0	3302	0	0	3231	0
Fl <sub>t</sub> Permitted		0.982			0.983			0.917			0.692	
Satd. Flow (perm)	0	3227	0	0	3329	0	0	3031	0	0	2240	0
Right Turn on Red			Yes			Yes			Yes			No
Satd. Flow (RTOR)		4			9			9				
Link Speed (mph)		30			30			30			30	
Link Distance (ft)		344			754			613			765	
Travel Time (s)		7.8			17.1			13.9			17.4	
Confl. Bikes (#/hr)			32			4			1			2
Peak Hour Factor	0.82	0.74	0.55	0.72	0.77	0.80	0.56	0.86	0.69	0.71	0.80	0.84
Heavy Vehicles (%)	3%	6%	9%	0%	2%	0%	0%	0%	0%	6%	0%	3%
Shared Lane Traffic (%)												
Lane Group Flow (vph)	0	375	0	0	534	0	0	1281	0	0	561	0
Enter Blocked Intersection	No	No	No	No	No	No	No	No	No	No	No	No
Lane Alignment	Left	Left	Right	Left	Left	Right	Left	Left	Right	Left	Left	Right
Median Width(ft)		0			0			0			0	
Link Offset(ft)		0			0			0			0	
Crosswalk Width(ft)		16			16			16			16	
Two way Left Turn Lane												
Headway Factor	1.04	1.04	1.04	1.04	1.04	1.04	1.10	1.10	1.10	1.10	1.10	1.10
Turning Speed (mph)	15		9	15		9	15		9	15		9
Number of Detectors	1	1		1	1		1	1		1	1	
Detector Template	Left			Left			Left			Left		
Leading Detector (ft)	20	39		20	39		20	45		20	48	
Trailing Detector (ft)	0	33		0	33		0	39		0	42	
Detector 1 Position(ft)	0	33		0	33		0	39		0	42	
Detector 1 Size(ft)	20	6		20	6		20	6		20	6	
Detector 1 Type	Cl+Ex	Cl+Ex		Cl+Ex	Cl+Ex		Cl+Ex	Cl+Ex		Cl+Ex	Cl+Ex	
Detector 1 Channel												
Detector 1 Extend (s)	0.0	0.0		0.0	0.0		0.0	0.0		0.0	0.0	
Detector 1 Queue (s)	0.0	0.0		0.0	0.0		0.0	0.0		0.0	0.0	
Detector 1 Delay (s)	0.0	0.0		0.0	0.0		0.0	0.0		0.0	0.0	
Turn Type	Split	NA		Split	NA		Perm	NA		Perm	NA	
Protected Phases	4	4		8	8			2			6	
Permitted Phases							2			6		
Detector Phase	4	4		8	8		2	2		6	6	

# 1: Alewife Brook Pkwy & Broadway













## Lanes, Volumes, Timings

11/18/2022

Lane Group	Ø9
Lane Configurations	
Traffic Volume (vph)	
Future Volume (vph)	
Ideal Flow (vphpl)	
Lane Width (ft)	
Grade (%)	
Storage Length (ft)	
Storage Lanes	
Taper Length (ft)	
Lane Util. Factor	
Ped Bike Factor	
Frt	
Flt Protected	
Satd. Flow (prot)	
Flt Permitted	
Satd. Flow (perm)	
Right Turn on Red	
Satd. Flow (RTOR)	
Link Speed (mph)	
Link Distance (ft)	
Travel Time (s)	
Confl. Bikes (#/hr)	
Peak Hour Factor	
Heavy Vehicles (%)	
Shared Lane Traffic (%)	
Lane Group Flow (vph)	
Enter Blocked Intersection	
Lane Alignment	
Median Width(ft)	
Link Offset(ft)	
Crosswalk Width(ft)	
Two way Left Turn Lane	
Headway Factor	
Turning Speed (mph)	
Number of Detectors	
Detector Template	
Leading Detector (ft)	
Trailing Detector (ft)	
Detector 1 Position(ft)	
Detector 1 Size(ft)	
Detector 1 Type	
Detector 1 Channel	
Detector 1 Extend (s)	
Detector 1 Queue (s)	
Detector 1 Delay (s)	
Turn Type	
Protected Phases	9
Permitted Phases	
Detector Phase	

1: Alewife Brook Pkwy & Broadway  
Lanes, Volumes, Timings

11/18/2022

												
Lane Group	EBL	EBT	EBR	WBL	WBT	WBR	NBL	NBT	NBR	SBL	SBT	SBR
Switch Phase												
Minimum Initial (s)	8.0	8.0		12.0	12.0		12.0	12.0		8.0	8.0	
Minimum Split (s)	14.0	14.0		18.0	18.0		18.0	18.0		14.0	14.0	
Total Split (s)	31.0	31.0		26.0	26.0		56.0	56.0		56.0	56.0	
Total Split (%)	23.5%	23.5%		19.7%	19.7%		42.4%	42.4%		42.4%	42.4%	
Maximum Green (s)	25.0	25.0		20.0	20.0		50.0	50.0		50.0	50.0	
Yellow Time (s)	4.0	4.0		4.0	4.0		4.0	4.0		4.0	4.0	
All-Red Time (s)	2.0	2.0		2.0	2.0		2.0	2.0		2.0	2.0	
Lost Time Adjust (s)		0.0			0.0			0.0			0.0	
Total Lost Time (s)		6.0			6.0			6.0			6.0	
Lead/Lag	Lead	Lead		Lag	Lag							
Lead-Lag Optimize?	Yes	Yes		Yes	Yes							
Vehicle Extension (s)	3.0	3.0		3.0	3.0		3.0	3.0		3.0	3.0	
Recall Mode	None	None		None	None		Min	Min		Min	Min	
Walk Time (s)												
Flash Dont Walk (s)												
Pedestrian Calls (#/hr)												
Act Effct Green (s)		18.9			20.0			50.0			50.0	
Actuated g/C Ratio		0.15			0.16			0.40			0.40	
v/c Ratio		0.77			1.00			1.06			0.63	
Control Delay		62.0			90.2			80.2			35.0	
Queue Delay		0.0			0.0			0.0			0.0	
Total Delay		62.0			90.2			80.2			35.0	
LOS		E			F			F			D	
Approach Delay		62.0			90.2			80.2			35.0	
Approach LOS		E			F			F			D	
90th %ile Green (s)	24.8	24.8		20.0	20.0		50.0	50.0		50.0	50.0	
90th %ile Term Code	Gap	Gap		Max	Max		Max	Max		Hold	Hold	
70th %ile Green (s)	21.2	21.2		20.0	20.0		50.0	50.0		50.0	50.0	
70th %ile Term Code	Gap	Gap		Max	Max		Max	Max		Hold	Hold	
50th %ile Green (s)	18.9	18.9		20.0	20.0		50.0	50.0		50.0	50.0	
50th %ile Term Code	Gap	Gap		Max	Max		Max	Max		Hold	Hold	
30th %ile Green (s)	16.6	16.6		20.0	20.0		50.0	50.0		50.0	50.0	
30th %ile Term Code	Gap	Gap		Max	Max		Max	Max		Hold	Hold	
10th %ile Green (s)	13.5	13.5		20.0	20.0		50.0	50.0		50.0	50.0	
10th %ile Term Code	Gap	Gap		Max	Max		Max	Max		Hold	Hold	
Stops (vph)		264			349			915			355	
Fuel Used(gal)		6			12			28			8	
CO Emissions (g/hr)		407			819			1935			549	
NOx Emissions (g/hr)		79			159			376			107	
VOC Emissions (g/hr)		94			190			448			127	
Dilemma Vehicles (#)		0			0			0			0	
Queue Length 50th (ft)		154			227			~601			191	
Queue Length 95th (ft)		166			#284			#737			233	
Internal Link Dist (ft)		264			674			533			685	
Turn Bay Length (ft)												
Base Capacity (vph)		643			536			1209			889	
Starvation Cap Reductn		0			0			0			0	
Spillback Cap Reductn		0			0			0			0	

1: Alewife Brook Pkwy & Broadway  
Lanes, Volumes, Timings

11/18/2022

Lane Group	Ø9
Switch Phase	
Minimum Initial (s)	1.0
Minimum Split (s)	19.0
Total Split (s)	19.0
Total Split (%)	14%
Maximum Green (s)	15.0
Yellow Time (s)	4.0
All-Red Time (s)	0.0
Lost Time Adjust (s)	
Total Lost Time (s)	
Lead/Lag	
Lead-Lag Optimize?	
Vehicle Extension (s)	3.0
Recall Mode	None
Walk Time (s)	7.0
Flash Dont Walk (s)	8.0
Pedestrian Calls (#/hr)	100
Act Effct Green (s)	
Actuated g/C Ratio	
v/c Ratio	
Control Delay	
Queue Delay	
Total Delay	
LOS	
Approach Delay	
Approach LOS	
90th %ile Green (s)	15.0
90th %ile Term Code	Ped
70th %ile Green (s)	15.0
70th %ile Term Code	Ped
50th %ile Green (s)	15.0
50th %ile Term Code	Ped
30th %ile Green (s)	15.0
30th %ile Term Code	Ped
10th %ile Green (s)	15.0
10th %ile Term Code	Ped
Stops (vph)	
Fuel Used(gal)	
CO Emissions (g/hr)	
NOx Emissions (g/hr)	
VOC Emissions (g/hr)	
Dilemma Vehicles (#)	
Queue Length 50th (ft)	
Queue Length 95th (ft)	
Internal Link Dist (ft)	
Turn Bay Length (ft)	
Base Capacity (vph)	
Starvation Cap Reductn	
Spillback Cap Reductn	

1: Alewife Brook Pkwy & Broadway  
Lanes, Volumes, Timings

11/18/2022

Lane Group	EBL	EBT	EBR	WBL	WBT	WBR	NBL	NBT	NBR	SBL	SBT	SBR
Storage Cap Reductn		0			0			0			0	
Reduced v/c Ratio		0.58			1.00			1.06			0.63	

Intersection Summary

Area Type:	Other
Cycle Length:	132
Actuated Cycle Length:	126
Natural Cycle:	110
Control Type:	Actuated-Uncoordinated
Maximum v/c Ratio:	1.06
Intersection Signal Delay:	70.4
Intersection Capacity Utilization	78.4%
Analysis Period (min)	15
90th %ile Actuated Cycle:	131.8
70th %ile Actuated Cycle:	128.2
50th %ile Actuated Cycle:	125.9
30th %ile Actuated Cycle:	123.6
10th %ile Actuated Cycle:	120.5
~	Volume exceeds capacity, queue is theoretically infinite. Queue shown is maximum after two cycles.
#	95th percentile volume exceeds capacity, queue may be longer. Queue shown is maximum after two cycles.

Splits and Phases: 1: Alewife Brook Pkwy & Broadway

Ø2 56 s	Ø9 19 s	Ø4 31 s	Ø8 26 s
Ø6 56 s			

Lane Group                      Ø9

---

Storage Cap Reductn

Reduced v/c Ratio

---

Intersection Summary

---

## 2: Broadway & Sunnyside Ave HCM Unsignalized Intersection Capacity Analysis

11/18/2022

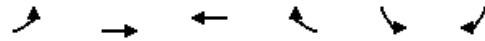













Movement	EBL	EBT	WBT	WBR	SBL	SBR
Lane Configurations		↶	↷		↶	↷
Traffic Volume (veh/h)	5	458	299	2	13	13
Future Volume (Veh/h)	5	458	299	2	13	13
Sign Control		Free	Free		Stop	
Grade		0%	0%		0%	
Peak Hour Factor	0.42	0.95	0.89	0.50	0.65	0.54
Hourly flow rate (vph)	12	482	336	4	20	24
Pedestrians		19	19		19	
Lane Width (ft)		16.0	16.0		12.0	
Walking Speed (ft/s)		3.5	3.5		3.5	
Percent Blockage		2	2		2	
Right turn flare (veh)						
Median type		None	None			
Median storage (veh)						
Upstream signal (ft)			344			
pX, platoon unblocked	0.86				0.86	0.86
vC, conflicting volume	359				882	376
vC1, stage 1 conf vol						
vC2, stage 2 conf vol						
vCu, unblocked vol	167				778	187
tC, single (s)	4.1				6.4	6.2
tC, 2 stage (s)						
tF (s)	2.2				3.5	3.3
p0 queue free %	99				93	97
cM capacity (veh/h)	1196				299	706
Direction, Lane #	EB 1	WB 1	SB 1			
Volume Total	494	340	44			
Volume Left	12	0	20			
Volume Right	0	4	24			
cSH	1196	1700	436			
Volume to Capacity	0.01	0.20	0.10			
Queue Length 95th (ft)	1	0	8			
Control Delay (s)	0.3	0.0	14.2			
Lane LOS	A		B			
Approach Delay (s)	0.3	0.0	14.2			
Approach LOS			B			
<b>Intersection Summary</b>						
Average Delay			0.9			
Intersection Capacity Utilization			42.8%		ICU Level of Service	A
Analysis Period (min)			15			



1: Alewife Brook Pkwy & Broadway  
Lanes, Volumes, Timings

11/18/2022

												
Lane Group	EBL	EBT	EBR	WBL	WBT	WBR	NBL	NBT	NBR	SBL	SBT	SBR
Lane Configurations		↕↕			↕↕			↕↕			↕↕	
Traffic Volume (vph)	119	250	16	175	256	25	4	776	103	19	729	147
Future Volume (vph)	119	250	16	175	256	25	4	776	103	19	729	147
Ideal Flow (vphpl)	1900	1900	1900	1900	1900	1900	1900	1900	1900	1900	1900	1900
Lane Width (ft)	11	11	11	11	11	11	10	10	10	10	10	10
Grade (%)		0%			0%			1%			1%	
Storage Length (ft)	0		0	0		175	0		0	0		0
Storage Lanes	0		0	0		1	0		0	0		0
Taper Length (ft)	25			25			25			25		
Lane Util. Factor	0.95	0.95	0.95	0.95	0.95	0.95	0.95	0.95	0.95	0.95	0.95	0.95
Ped Bike Factor		1.00			1.00			1.00				
Fr <sub>t</sub>		0.992			0.989			0.983			0.973	
Fl <sub>t</sub> Protected		0.985			0.983						0.999	
Satd. Flow (prot)	0	3364	0	0	3350	0	0	3291	0	0	3259	0
Fl <sub>t</sub> Permitted		0.985			0.983			0.946			0.745	
Satd. Flow (perm)	0	3364	0	0	3350	0	0	3113	0	0	2430	0
Right Turn on Red			Yes			Yes			Yes			No
Satd. Flow (RTOR)		4			5			12				
Link Speed (mph)		30			30			30			30	
Link Distance (ft)		344			754			613			765	
Travel Time (s)		7.8			17.1			13.9			17.4	
Confl. Bikes (#/hr)			3			3			1			
Peak Hour Factor	0.88	0.91	0.67	0.81	0.72	0.57	0.50	0.79	0.83	0.68	0.95	0.83
Heavy Vehicles (%)	0%	2%	0%	0%	2%	0%	0%	0%	0%	0%	0%	0%
Adj. Flow (vph)	135	275	24	216	356	44	8	982	124	28	767	177
Shared Lane Traffic (%)												
Lane Group Flow (vph)	0	434	0	0	616	0	0	1114	0	0	972	0
Enter Blocked Intersection	No	No	No	No	No	No	No	No	No	No	No	No
Lane Alignment	Left	Left	Right	Left	Left	Right	Left	Left	Right	Left	Left	Right
Median Width(ft)		0			0			0			0	
Link Offset(ft)		0			0			0			0	
Crosswalk Width(ft)		16			16			16			16	
Two way Left Turn Lane												
Headway Factor	1.04	1.04	1.04	1.04	1.04	1.04	1.10	1.10	1.10	1.10	1.10	1.10
Turning Speed (mph)	15		9	15		9	15		9	15		9
Number of Detectors	1	1		1	1		1	1		1	1	
Detector Template	Left			Left			Left			Left		
Leading Detector (ft)	20	39		20	39		20	45		20	48	
Trailing Detector (ft)	0	33		0	33		0	39		0	42	
Detector 1 Position(ft)	0	33		0	33		0	39		0	42	
Detector 1 Size(ft)	20	6		20	6		20	6		20	6	
Detector 1 Type	Cl+Ex	Cl+Ex		Cl+Ex	Cl+Ex		Cl+Ex	Cl+Ex		Cl+Ex	Cl+Ex	
Detector 1 Channel												
Detector 1 Extend (s)	0.0	0.0		0.0	0.0		0.0	0.0		0.0	0.0	
Detector 1 Queue (s)	0.0	0.0		0.0	0.0		0.0	0.0		0.0	0.0	
Detector 1 Delay (s)	0.0	0.0		0.0	0.0		0.0	0.0		0.0	0.0	
Turn Type	Split	NA		Split	NA		Perm	NA		Perm	NA	
Protected Phases	4	4		8	8			2			6	
Permitted Phases							2			6		

# 1: Alewife Brook Pkwy & Broadway













## Lanes, Volumes, Timings

11/18/2022

Lane Group	Ø9
Lane Configurations	
Traffic Volume (vph)	
Future Volume (vph)	
Ideal Flow (vphpl)	
Lane Width (ft)	
Grade (%)	
Storage Length (ft)	
Storage Lanes	
Taper Length (ft)	
Lane Util. Factor	
Ped Bike Factor	
Frt	
Flt Protected	
Satd. Flow (prot)	
Flt Permitted	
Satd. Flow (perm)	
Right Turn on Red	
Satd. Flow (RTOR)	
Link Speed (mph)	
Link Distance (ft)	
Travel Time (s)	
Confl. Bikes (#/hr)	
Peak Hour Factor	
Heavy Vehicles (%)	
Adj. Flow (vph)	
Shared Lane Traffic (%)	
Lane Group Flow (vph)	
Enter Blocked Intersection	
Lane Alignment	
Median Width(ft)	
Link Offset(ft)	
Crosswalk Width(ft)	
Two way Left Turn Lane	
Headway Factor	
Turning Speed (mph)	
Number of Detectors	
Detector Template	
Leading Detector (ft)	
Trailing Detector (ft)	
Detector 1 Position(ft)	
Detector 1 Size(ft)	
Detector 1 Type	
Detector 1 Channel	
Detector 1 Extend (s)	
Detector 1 Queue (s)	
Detector 1 Delay (s)	
Turn Type	
Protected Phases	9
Permitted Phases	

1: Alewife Brook Pkwy & Broadway  
Lanes, Volumes, Timings

11/18/2022

												
Lane Group	EBL	EBT	EBR	WBL	WBT	WBR	NBL	NBT	NBR	SBL	SBT	SBR
Detector Phase	4	4		8	8		2	2		6	6	
Switch Phase												
Minimum Initial (s)	8.0	8.0		12.0	12.0		12.0	12.0		8.0	8.0	
Minimum Split (s)	14.0	14.0		18.0	18.0		18.0	18.0		14.0	14.0	
Total Split (s)	31.0	31.0		26.0	26.0		56.0	56.0		56.0	56.0	
Total Split (%)	23.5%	23.5%		19.7%	19.7%		42.4%	42.4%		42.4%	42.4%	
Maximum Green (s)	25.0	25.0		20.0	20.0		50.0	50.0		50.0	50.0	
Yellow Time (s)	4.0	4.0		4.0	4.0		4.0	4.0		4.0	4.0	
All-Red Time (s)	2.0	2.0		2.0	2.0		2.0	2.0		2.0	2.0	
Lost Time Adjust (s)		0.0			0.0			0.0			0.0	
Total Lost Time (s)		6.0			6.0			6.0			6.0	
Lead/Lag	Lead	Lead		Lag	Lag							
Lead-Lag Optimize?	Yes	Yes		Yes	Yes							
Vehicle Extension (s)	3.0	3.0		3.0	3.0		3.0	3.0		3.0	3.0	
Recall Mode	None	None		None	None		Min	Min		Min	Min	
Walk Time (s)												
Flash Dont Walk (s)												
Pedestrian Calls (#/hr)												
Act Effct Green (s)		20.4			20.0			50.0			50.0	
Actuated g/C Ratio		0.16			0.16			0.39			0.39	
v/c Ratio		0.80			1.16			0.91			1.02	
Control Delay		63.1			139.2			48.1			72.7	
Queue Delay		0.0			0.0			0.0			0.0	
Total Delay		63.1			139.2			48.1			72.7	
LOS		E			F			D			E	
Approach Delay		63.1			139.2			48.1			72.7	
Approach LOS		E			F			D			E	
90th %ile Green (s)	25.0	25.0		20.0	20.0		50.0	50.0		50.0	50.0	
90th %ile Term Code	Max	Max		Max	Max		Max	Max		Max	Max	
70th %ile Green (s)	23.2	23.2		20.0	20.0		50.0	50.0		50.0	50.0	
70th %ile Term Code	Gap	Gap		Max	Max		Max	Max		Max	Max	
50th %ile Green (s)	20.7	20.7		20.0	20.0		50.0	50.0		50.0	50.0	
50th %ile Term Code	Gap	Gap		Max	Max		Max	Max		Max	Max	
30th %ile Green (s)	18.3	18.3		20.0	20.0		50.0	50.0		50.0	50.0	
30th %ile Term Code	Gap	Gap		Max	Max		Hold	Hold		Max	Max	
10th %ile Green (s)	15.0	15.0		20.0	20.0		50.0	50.0		50.0	50.0	
10th %ile Term Code	Gap	Gap		Max	Max		Hold	Hold		Max	Max	
Stops (vph)		358			375			770			772	
Fuel Used(gal)		8			18			17			23	
CO Emissions (g/hr)		556			1235			1196			1598	
NOx Emissions (g/hr)		108			240			233			311	
VOC Emissions (g/hr)		129			286			277			370	
Dilemma Vehicles (#)		0			0			0			0	
Queue Length 50th (ft)		182			~317			449			~448	
Queue Length 95th (ft)		242			#318			471			#613	
Internal Link Dist (ft)		264			674			533			685	
Turn Bay Length (ft)												
Base Capacity (vph)		663			530			1229			954	
Starvation Cap Reductn		0			0			0			0	

1: Alewife Brook Pkwy & Broadway  
Lanes, Volumes, Timings

11/18/2022

Lane Group	Ø9
Detector Phase	
Switch Phase	
Minimum Initial (s)	1.0
Minimum Split (s)	19.0
Total Split (s)	19.0
Total Split (%)	14%
Maximum Green (s)	15.0
Yellow Time (s)	4.0
All-Red Time (s)	0.0
Lost Time Adjust (s)	
Total Lost Time (s)	
Lead/Lag	
Lead-Lag Optimize?	
Vehicle Extension (s)	3.0
Recall Mode	None
Walk Time (s)	7.0
Flash Dont Walk (s)	8.0
Pedestrian Calls (#/hr)	100
Act Effct Green (s)	
Actuated g/C Ratio	
v/c Ratio	
Control Delay	
Queue Delay	
Total Delay	
LOS	
Approach Delay	
Approach LOS	
90th %ile Green (s)	15.0
90th %ile Term Code	Ped
70th %ile Green (s)	15.0
70th %ile Term Code	Ped
50th %ile Green (s)	15.0
50th %ile Term Code	Ped
30th %ile Green (s)	15.0
30th %ile Term Code	Ped
10th %ile Green (s)	15.0
10th %ile Term Code	Ped
Stops (vph)	
Fuel Used(gal)	
CO Emissions (g/hr)	
NOx Emissions (g/hr)	
VOC Emissions (g/hr)	
Dilemma Vehicles (#)	
Queue Length 50th (ft)	
Queue Length 95th (ft)	
Internal Link Dist (ft)	
Turn Bay Length (ft)	
Base Capacity (vph)	
Starvation Cap Reductn	

# 1: Alewife Brook Pkwy & Broadway Lanes, Volumes, Timings

11/18/2022

Lane Group	EBL	EBT	EBR	WBL	WBT	WBR	NBL	NBT	NBR	SBL	SBT	SBR
Spillback Cap Reductn		0			0			0			0	
Storage Cap Reductn		0			0			0			0	
Reduced v/c Ratio		0.65			1.16			0.91			1.02	

## Intersection Summary

Area Type: Other

Cycle Length: 132

Actuated Cycle Length: 127.4

Natural Cycle: 120

Control Type: Actuated-Uncoordinated

Maximum v/c Ratio: 1.16

Intersection Signal Delay: 75.7      Intersection LOS: E

Intersection Capacity Utilization 77.6%      ICU Level of Service D

Analysis Period (min) 15

90th %ile Actuated Cycle: 132

70th %ile Actuated Cycle: 130.2

50th %ile Actuated Cycle: 127.7

30th %ile Actuated Cycle: 125.3

10th %ile Actuated Cycle: 122

~ Volume exceeds capacity, queue is theoretically infinite.  
Queue shown is maximum after two cycles.

# 95th percentile volume exceeds capacity, queue may be longer.  
Queue shown is maximum after two cycles.

## Splits and Phases: 1: Alewife Brook Pkwy & Broadway

Ø2 56 s	Ø9 19 s	Ø4 31 s	Ø8 26 s
Ø6 56 s			

Lane Group                      Ø9

---

Spillback Cap Reductn

Storage Cap Reductn

Reduced v/c Ratio

Intersection Summary

---

## 2: Broadway & Sunnyside Ave HCM Unsignalized Intersection Capacity Analysis



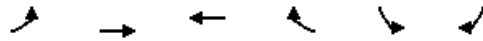













11/18/2022



Movement	EBL	EBT	WBT	WBR	SBL	SBR
Lane Configurations		↶	↷		↷	
Traffic Volume (veh/h)	5	435	358	17	23	19
Future Volume (Veh/h)	5	435	358	17	23	19
Sign Control		Free	Free		Stop	
Grade		0%	0%		0%	
Peak Hour Factor	0.42	0.87	0.88	0.61	0.56	0.62
Hourly flow rate (vph)	12	500	407	28	41	31
Pedestrians		23	23		23	
Lane Width (ft)		16.0	16.0		12.0	
Walking Speed (ft/s)		3.5	3.5		3.5	
Percent Blockage		3	3		2	
Right turn flare (veh)						
Median type		None	None			
Median storage (veh)						
Upstream signal (ft)			344			
pX, platoon unblocked	0.85				0.85	0.85
vC, conflicting volume	458				991	467
vC1, stage 1 conf vol						
vC2, stage 2 conf vol						
vCu, unblocked vol	270				899	281
tC, single (s)	4.1				6.4	6.2
tC, 2 stage (s)						
tF (s)	2.2				3.5	3.3
p0 queue free %	99				83	95
cM capacity (veh/h)	1081				248	614
Direction, Lane #	EB 1	WB 1	SB 1			
Volume Total	512	435	72			
Volume Left	12	0	41			
Volume Right	0	28	31			
cSH	1081	1700	334			
Volume to Capacity	0.01	0.26	0.22			
Queue Length 95th (ft)	1	0	20			
Control Delay (s)	0.3	0.0	18.7			
Lane LOS	A		C			
Approach Delay (s)	0.3	0.0	18.7			
Approach LOS			C			
<b>Intersection Summary</b>						
Average Delay			1.5			
Intersection Capacity Utilization			42.3%	ICU Level of Service		A
Analysis Period (min)			15			

1: Alewife Brook Pkwy & Broadway  
Lanes, Volumes, Timings

11/18/2022

												
Lane Group	EBL	EBT	EBR	WBL	WBT	WBR	NBL	NBT	NBR	SBL	SBT	SBR
Lane Configurations												
Traffic Volume (vph)	129	185	13	152	258	55	23	1120	89	20	413	85
Future Volume (vph)	129	185	13	152	258	55	23	1120	89	20	413	85
Ideal Flow (vphpl)	1900	1900	1900	1900	1900	1900	1900	1900	1900	1900	1900	1900
Lane Width (ft)	11	11	11	11	11	11	10	10	10	10	10	10
Grade (%)		0%			0%			1%			1%	
Storage Length (ft)	0		0	0		175	0		0	0		0
Storage Lanes	0		0	0		1	0		0	0		0
Taper Length (ft)	25			25			25			25		
Lane Util. Factor	0.95	0.95	0.95	0.95	0.95	0.95	0.95	0.95	0.95	0.95	0.95	0.95
Ped Bike Factor		1.00			1.00			1.00			1.00	
Fr <sub>t</sub>		0.992			0.983			0.987			0.977	
Fl <sub>t</sub> Protected		0.982			0.983			0.999			0.998	
Satd. Flow (prot)	0	3226	0	0	3329	0	0	3302	0	0	3234	0
Fl <sub>t</sub> Permitted		0.982			0.983			0.886			0.603	
Satd. Flow (perm)	0	3226	0	0	3329	0	0	2928	0	0	1954	0
Right Turn on Red			Yes			Yes			Yes			No
Satd. Flow (RTOR)		4			9			9				
Link Speed (mph)		30			30			30			30	
Link Distance (ft)		344			754			613			765	
Travel Time (s)		7.8			17.1			13.9			17.4	
Confl. Bikes (#/hr)			32			4			1			2
Peak Hour Factor	0.82	0.74	0.55	0.72	0.77	0.80	0.56	0.86	0.69	0.71	0.80	0.84
Heavy Vehicles (%)	3%	6%	9%	0%	2%	0%	0%	0%	0%	6%	0%	3%
Adj. Flow (vph)	157	250	24	211	335	69	41	1302	129	28	516	101
Shared Lane Traffic (%)												
Lane Group Flow (vph)	0	431	0	0	615	0	0	1472	0	0	645	0
Enter Blocked Intersection	No	No	No	No	No	No	No	No	No	No	No	No
Lane Alignment	Left	Left	Right	Left	Left	Right	Left	Left	Right	Left	Left	Right
Median Width(ft)		0			0			0			0	
Link Offset(ft)		0			0			0			0	
Crosswalk Width(ft)		16			16			16			16	
Two way Left Turn Lane												
Headway Factor	1.04	1.04	1.04	1.04	1.04	1.04	1.10	1.10	1.10	1.10	1.10	1.10
Turning Speed (mph)	15		9	15		9	15		9	15		9
Number of Detectors	1	1		1	1		1	1		1	1	
Detector Template	Left			Left			Left			Left		
Leading Detector (ft)	20	39		20	39		20	45		20	48	
Trailing Detector (ft)	0	33		0	33		0	39		0	42	
Detector 1 Position(ft)	0	33		0	33		0	39		0	42	
Detector 1 Size(ft)	20	6		20	6		20	6		20	6	
Detector 1 Type	Cl+Ex	Cl+Ex		Cl+Ex	Cl+Ex		Cl+Ex	Cl+Ex		Cl+Ex	Cl+Ex	
Detector 1 Channel												
Detector 1 Extend (s)	0.0	0.0		0.0	0.0		0.0	0.0		0.0	0.0	
Detector 1 Queue (s)	0.0	0.0		0.0	0.0		0.0	0.0		0.0	0.0	
Detector 1 Delay (s)	0.0	0.0		0.0	0.0		0.0	0.0		0.0	0.0	
Turn Type	Split	NA		Split	NA		Perm	NA		Perm	NA	
Protected Phases	4	4		8	8			2			6	
Permitted Phases							2			6		















1: Alewife Brook Pkwy & Broadway  
Lanes, Volumes, Timings

11/18/2022

Lane Group	Ø9
Lane Configurations	
Traffic Volume (vph)	
Future Volume (vph)	
Ideal Flow (vphpl)	
Lane Width (ft)	
Grade (%)	
Storage Length (ft)	
Storage Lanes	
Taper Length (ft)	
Lane Util. Factor	
Ped Bike Factor	
Frt	
Flt Protected	
Satd. Flow (prot)	
Flt Permitted	
Satd. Flow (perm)	
Right Turn on Red	
Satd. Flow (RTOR)	
Link Speed (mph)	
Link Distance (ft)	
Travel Time (s)	
Confl. Bikes (#/hr)	
Peak Hour Factor	
Heavy Vehicles (%)	
Adj. Flow (vph)	
Shared Lane Traffic (%)	
Lane Group Flow (vph)	
Enter Blocked Intersection	
Lane Alignment	
Median Width(ft)	
Link Offset(ft)	
Crosswalk Width(ft)	
Two way Left Turn Lane	
Headway Factor	
Turning Speed (mph)	
Number of Detectors	
Detector Template	
Leading Detector (ft)	
Trailing Detector (ft)	
Detector 1 Position(ft)	
Detector 1 Size(ft)	
Detector 1 Type	
Detector 1 Channel	
Detector 1 Extend (s)	
Detector 1 Queue (s)	
Detector 1 Delay (s)	
Turn Type	
Protected Phases	9
Permitted Phases	

1: Alewife Brook Pkwy & Broadway  
Lanes, Volumes, Timings

11/18/2022

												
Lane Group	EBL	EBT	EBR	WBL	WBT	WBR	NBL	NBT	NBR	SBL	SBT	SBR
Detector Phase	4	4		8	8		2	2		6	6	
Switch Phase												
Minimum Initial (s)	8.0	8.0		12.0	12.0		12.0	12.0		8.0	8.0	
Minimum Split (s)	14.0	14.0		18.0	18.0		18.0	18.0		14.0	14.0	
Total Split (s)	31.0	31.0		26.0	26.0		56.0	56.0		56.0	56.0	
Total Split (%)	23.5%	23.5%		19.7%	19.7%		42.4%	42.4%		42.4%	42.4%	
Maximum Green (s)	25.0	25.0		20.0	20.0		50.0	50.0		50.0	50.0	
Yellow Time (s)	4.0	4.0		4.0	4.0		4.0	4.0		4.0	4.0	
All-Red Time (s)	2.0	2.0		2.0	2.0		2.0	2.0		2.0	2.0	
Lost Time Adjust (s)		0.0			0.0			0.0			0.0	
Total Lost Time (s)		6.0			6.0			6.0			6.0	
Lead/Lag	Lead	Lead		Lag	Lag							
Lead-Lag Optimize?	Yes	Yes		Yes	Yes							
Vehicle Extension (s)	3.0	3.0		3.0	3.0		3.0	3.0		3.0	3.0	
Recall Mode	None	None		None	None		Min	Min		Min	Min	
Walk Time (s)												
Flash Dont Walk (s)												
Pedestrian Calls (#/hr)												
Act Effct Green (s)		20.9			20.0			50.0			50.0	
Actuated g/C Ratio		0.16			0.16			0.39			0.39	
v/c Ratio		0.81			1.16			1.28			0.84	
Control Delay		64.2			139.6			166.5			47.7	
Queue Delay		0.0			0.0			0.0			0.0	
Total Delay		64.2			139.6			166.5			47.7	
LOS		E			F			F			D	
Approach Delay		64.2			139.6			166.5			47.7	
Approach LOS		E			F			F			D	
90th %ile Green (s)	25.0	25.0		20.0	20.0		50.0	50.0		50.0	50.0	
90th %ile Term Code	Max	Max		Max	Max		Max	Max		Max	Max	
70th %ile Green (s)	24.0	24.0		20.0	20.0		50.0	50.0		50.0	50.0	
70th %ile Term Code	Gap	Gap		Max	Max		Max	Max		Max	Max	
50th %ile Green (s)	21.4	21.4		20.0	20.0		50.0	50.0		50.0	50.0	
50th %ile Term Code	Gap	Gap		Max	Max		Max	Max		Hold	Hold	
30th %ile Green (s)	18.9	18.9		20.0	20.0		50.0	50.0		50.0	50.0	
30th %ile Term Code	Gap	Gap		Max	Max		Max	Max		Hold	Hold	
10th %ile Green (s)	15.4	15.4		20.0	20.0		50.0	50.0		50.0	50.0	
10th %ile Term Code	Gap	Gap		Max	Max		Max	Max		Hold	Hold	
Stops (vph)		306			380			982			447	
Fuel Used(gal)		7			18			53			11	
CO Emissions (g/hr)		478			1262			3710			740	
NOx Emissions (g/hr)		93			246			722			144	
VOC Emissions (g/hr)		111			292			860			172	
Dilemma Vehicles (#)		0			0			0			0	
Queue Length 50th (ft)		182			~317			~820			254	
Queue Length 95th (ft)		191			#355			#932			296	
Internal Link Dist (ft)		264			674			533			685	
Turn Bay Length (ft)												
Base Capacity (vph)		634			528			1150			764	
Starvation Cap Reductn		0			0			0			0	

1: Alewife Brook Pkwy & Broadway  
Lanes, Volumes, Timings

11/18/2022

Lane Group	Ø9
Detector Phase	
Switch Phase	
Minimum Initial (s)	1.0
Minimum Split (s)	19.0
Total Split (s)	19.0
Total Split (%)	14%
Maximum Green (s)	15.0
Yellow Time (s)	4.0
All-Red Time (s)	0.0
Lost Time Adjust (s)	
Total Lost Time (s)	
Lead/Lag	
Lead-Lag Optimize?	
Vehicle Extension (s)	3.0
Recall Mode	None
Walk Time (s)	7.0
Flash Dont Walk (s)	8.0
Pedestrian Calls (#/hr)	100
Act Effct Green (s)	
Actuated g/C Ratio	
v/c Ratio	
Control Delay	
Queue Delay	
Total Delay	
LOS	
Approach Delay	
Approach LOS	
90th %ile Green (s)	15.0
90th %ile Term Code	Ped
70th %ile Green (s)	15.0
70th %ile Term Code	Ped
50th %ile Green (s)	15.0
50th %ile Term Code	Ped
30th %ile Green (s)	15.0
30th %ile Term Code	Ped
10th %ile Green (s)	15.0
10th %ile Term Code	Ped
Stops (vph)	
Fuel Used(gal)	
CO Emissions (g/hr)	
NOx Emissions (g/hr)	
VOC Emissions (g/hr)	
Dilemma Vehicles (#)	
Queue Length 50th (ft)	
Queue Length 95th (ft)	
Internal Link Dist (ft)	
Turn Bay Length (ft)	
Base Capacity (vph)	
Starvation Cap Reductn	

# 1: Alewife Brook Pkwy & Broadway Lanes, Volumes, Timings

11/18/2022

Lane Group	EBL	EBT	EBR	WBL	WBT	WBR	NBL	NBT	NBR	SBL	SBT	SBR
Spillback Cap Reductn		0			0			0			0	
Storage Cap Reductn		0			0			0			0	
Reduced v/c Ratio		0.68			1.16			1.28			0.84	

## Intersection Summary

Area Type: Other

Cycle Length: 132

Actuated Cycle Length: 127.9

Natural Cycle: 150

Control Type: Actuated-Uncoordinated

Maximum v/c Ratio: 1.28

Intersection Signal Delay: 123.1

Intersection LOS: F

Intersection Capacity Utilization 87.9%

ICU Level of Service E

Analysis Period (min) 15

90th %ile Actuated Cycle: 132

70th %ile Actuated Cycle: 131

50th %ile Actuated Cycle: 128.4

30th %ile Actuated Cycle: 125.9

10th %ile Actuated Cycle: 122.4

~ Volume exceeds capacity, queue is theoretically infinite.

Queue shown is maximum after two cycles.

# 95th percentile volume exceeds capacity, queue may be longer.

Queue shown is maximum after two cycles.

## Splits and Phases: 1: Alewife Brook Pkwy & Broadway

Ø2 56 s	Ø9 19 s	Ø4 31 s	Ø8 26 s
Ø6 56 s			

Lane Group	Ø9
Spillback Cap Reductn	
Storage Cap Reductn	
Reduced v/c Ratio	
Intersection Summary	

## 2: Broadway & Sunnyside Ave HCM Unsignalized Intersection Capacity Analysis

















11/18/2022



Movement	EBL	EBT	WBT	WBR	SBL	SBR
Lane Configurations		↔	↔		↔	
Traffic Volume (veh/h)	6	527	344	2	15	15
Future Volume (Veh/h)	6	527	344	2	15	15
Sign Control		Free	Free		Stop	
Grade		0%	0%		0%	
Peak Hour Factor	0.42	0.95	0.89	0.50	0.65	0.54
Hourly flow rate (vph)	14	555	387	4	23	28
Pedestrians		19	19		19	
Lane Width (ft)		16.0	16.0		12.0	
Walking Speed (ft/s)		3.5	3.5		3.5	
Percent Blockage		2	2		2	
Right turn flare (veh)						
Median type		None	None			
Median storage (veh)						
Upstream signal (ft)			344			
pX, platoon unblocked	0.85				0.85	0.85
vC, conflicting volume	410				1010	427
vC1, stage 1 conf vol						
vC2, stage 2 conf vol						
vCu, unblocked vol	217				923	237
tC, single (s)	4.1				6.4	6.2
tC, 2 stage (s)						
tF (s)	2.2				3.5	3.3
p0 queue free %	99				91	96
cM capacity (veh/h)	1138				243	657
<b>Direction, Lane #</b>	<b>EB 1</b>	<b>WB 1</b>	<b>SB 1</b>			
Volume Total	569	391	51			
Volume Left	14	0	23			
Volume Right	0	4	28			
cSH	1138	1700	371			
Volume to Capacity	0.01	0.23	0.14			
Queue Length 95th (ft)	1	0	12			
Control Delay (s)	0.3	0.0	16.2			
Lane LOS	A		C			
Approach Delay (s)	0.3	0.0	16.2			
Approach LOS			C			
<b>Intersection Summary</b>						
Average Delay			1.0			
Intersection Capacity Utilization			47.2%	ICU Level of Service		A
Analysis Period (min)			15			

1: Alewife Brook Pkwy & Broadway  
Lanes, Volumes, Timings

11/18/2022

												
Lane Group	EBL	EBT	EBR	WBL	WBT	WBR	NBL	NBT	NBR	SBL	SBT	SBR
Lane Configurations												
Traffic Volume (vph)	137	288	18	201	294	29	5	892	119	22	838	169
Future Volume (vph)	137	288	18	201	294	29	5	892	119	22	838	169
Ideal Flow (vphpl)	1900	1900	1900	1900	1900	1900	1900	1900	1900	1900	1900	1900
Lane Width (ft)	11	11	11	11	11	11	10	10	10	10	10	10
Grade (%)		0%			0%			1%			1%	
Storage Length (ft)	0		0	0		175	0		0	0		0
Storage Lanes	0		0	0		1	0		0	0		0
Taper Length (ft)	25			25			25			25		
Lane Util. Factor	0.95	0.95	0.95	0.95	0.95	0.95	0.95	0.95	0.95	0.95	0.95	0.95
Ped Bike Factor		1.00			1.00			1.00				
Fr <sub>t</sub>		0.992			0.989			0.983				0.973
Fl <sub>t</sub> Protected		0.985			0.983							0.999
Satd. Flow (prot)	0	3364	0	0	3350	0	0	3291	0	0	3259	0
Fl <sub>t</sub> Permitted		0.985			0.983			0.887				0.642
Satd. Flow (perm)	0	3364	0	0	3350	0	0	2919	0	0	2094	0
Right Turn on Red			Yes			Yes			Yes			No
Satd. Flow (RTOR)		4			5			12				
Link Speed (mph)		30			30			30				30
Link Distance (ft)		344			754			613				765
Travel Time (s)		7.8			17.1			13.9				17.4
Confl. Bikes (#/hr)			3			3			1			
Peak Hour Factor	0.88	0.91	0.67	0.81	0.72	0.57	0.50	0.79	0.83	0.68	0.95	0.83
Heavy Vehicles (%)	0%	2%	0%	0%	2%	0%	0%	0%	0%	0%	0%	0%
Adj. Flow (vph)	156	316	27	248	408	51	10	1129	143	32	882	204
Shared Lane Traffic (%)												
Lane Group Flow (vph)	0	499	0	0	707	0	0	1282	0	0	1118	0
Enter Blocked Intersection	No	No	No	No	No	No	No	No	No	No	No	No
Lane Alignment	Left	Left	Right	Left	Left	Right	Left	Left	Right	Left	Left	Right
Median Width(ft)		0			0			0			0	
Link Offset(ft)		0			0			0			0	
Crosswalk Width(ft)		16			16			16			16	
Two way Left Turn Lane												
Headway Factor	1.04	1.04	1.04	1.04	1.04	1.04	1.10	1.10	1.10	1.10	1.10	1.10
Turning Speed (mph)	15		9	15		9	15		9	15		9
Number of Detectors	1	1		1	1		1	1		1	1	
Detector Template	Left			Left			Left			Left		
Leading Detector (ft)	20	39		20	39		20	45		20	48	
Trailing Detector (ft)	0	33		0	33		0	39		0	42	
Detector 1 Position(ft)	0	33		0	33		0	39		0	42	
Detector 1 Size(ft)	20	6		20	6		20	6		20	6	
Detector 1 Type	Cl+Ex	Cl+Ex		Cl+Ex	Cl+Ex		Cl+Ex	Cl+Ex		Cl+Ex	Cl+Ex	
Detector 1 Channel												
Detector 1 Extend (s)	0.0	0.0		0.0	0.0		0.0	0.0		0.0	0.0	
Detector 1 Queue (s)	0.0	0.0		0.0	0.0		0.0	0.0		0.0	0.0	
Detector 1 Delay (s)	0.0	0.0		0.0	0.0		0.0	0.0		0.0	0.0	
Turn Type	Split	NA		Split	NA		Perm	NA		Perm	NA	
Protected Phases	4	4		8	8			2			6	
Permitted Phases								2			6	

# 1: Alewife Brook Pkwy & Broadway

## Lanes, Volumes, Timings













11/18/2022

Lane Group	Ø9
Lane Configurations	
Traffic Volume (vph)	
Future Volume (vph)	
Ideal Flow (vphpl)	
Lane Width (ft)	
Grade (%)	
Storage Length (ft)	
Storage Lanes	
Taper Length (ft)	
Lane Util. Factor	
Ped Bike Factor	
Frt	
Flt Protected	
Satd. Flow (prot)	
Flt Permitted	
Satd. Flow (perm)	
Right Turn on Red	
Satd. Flow (RTOR)	
Link Speed (mph)	
Link Distance (ft)	
Travel Time (s)	
Confl. Bikes (#/hr)	
Peak Hour Factor	
Heavy Vehicles (%)	
Adj. Flow (vph)	
Shared Lane Traffic (%)	
Lane Group Flow (vph)	
Enter Blocked Intersection	
Lane Alignment	
Median Width(ft)	
Link Offset(ft)	
Crosswalk Width(ft)	
Two way Left Turn Lane	
Headway Factor	
Turning Speed (mph)	
Number of Detectors	
Detector Template	
Leading Detector (ft)	
Trailing Detector (ft)	
Detector 1 Position(ft)	
Detector 1 Size(ft)	
Detector 1 Type	
Detector 1 Channel	
Detector 1 Extend (s)	
Detector 1 Queue (s)	
Detector 1 Delay (s)	
Turn Type	
Protected Phases	9
Permitted Phases	



1: Alewife Brook Pkwy & Broadway  
Lanes, Volumes, Timings

11/18/2022

												
Lane Group	EBL	EBT	EBR	WBL	WBT	WBR	NBL	NBT	NBR	SBL	SBT	SBR
Detector Phase	4	4		8	8		2	2		6	6	
Switch Phase												
Minimum Initial (s)	8.0	8.0		12.0	12.0		12.0	12.0		8.0	8.0	
Minimum Split (s)	14.0	14.0		18.0	18.0		18.0	18.0		14.0	14.0	
Total Split (s)	31.0	31.0		26.0	26.0		56.0	56.0		56.0	56.0	
Total Split (%)	23.5%	23.5%		19.7%	19.7%		42.4%	42.4%		42.4%	42.4%	
Maximum Green (s)	25.0	25.0		20.0	20.0		50.0	50.0		50.0	50.0	
Yellow Time (s)	4.0	4.0		4.0	4.0		4.0	4.0		4.0	4.0	
All-Red Time (s)	2.0	2.0		2.0	2.0		2.0	2.0		2.0	2.0	
Lost Time Adjust (s)		0.0			0.0			0.0			0.0	
Total Lost Time (s)		6.0			6.0			6.0			6.0	
Lead/Lag	Lead	Lead		Lag	Lag							
Lead-Lag Optimize?	Yes	Yes		Yes	Yes							
Vehicle Extension (s)	3.0	3.0		3.0	3.0		3.0	3.0		3.0	3.0	
Recall Mode	None	None		None	None		Min	Min		Min	Min	
Walk Time (s)												
Flash Dont Walk (s)												
Pedestrian Calls (#/hr)												
Act Effct Green (s)		22.3			20.0			50.0			50.0	
Actuated g/C Ratio		0.17			0.15			0.39			0.39	
v/c Ratio		0.85			1.35			1.13			1.38	
Control Delay		66.4			213.2			106.5			212.2	
Queue Delay		0.0			0.0			0.0			0.0	
Total Delay		66.4			213.2			106.5			212.2	
LOS		E			F			F			F	
Approach Delay		66.4			213.2			106.5			212.2	
Approach LOS		E			F			F			F	
90th %ile Green (s)	25.0	25.0		20.0	20.0		50.0	50.0		50.0	50.0	
90th %ile Term Code	Max	Max		Max	Max		Max	Max		Max	Max	
70th %ile Green (s)	25.0	25.0		20.0	20.0		50.0	50.0		50.0	50.0	
70th %ile Term Code	Max	Max		Max	Max		Max	Max		Max	Max	
50th %ile Green (s)	23.7	23.7		20.0	20.0		50.0	50.0		50.0	50.0	
50th %ile Term Code	Gap	Gap		Max	Max		Max	Max		Max	Max	
30th %ile Green (s)	21.0	21.0		20.0	20.0		50.0	50.0		50.0	50.0	
30th %ile Term Code	Gap	Gap		Max	Max		Max	Max		Max	Max	
10th %ile Green (s)	17.3	17.3		20.0	20.0		50.0	50.0		50.0	50.0	
10th %ile Term Code	Gap	Gap		Max	Max		Max	Max		Max	Max	
Stops (vph)		417			402			851			785	
Fuel Used(gal)		9			28			32			55	
CO Emissions (g/hr)		663			1961			2207			3839	
NOx Emissions (g/hr)		129			381			429			747	
VOC Emissions (g/hr)		154			454			512			890	
Dilemma Vehicles (#)		0			0			0			0	
Queue Length 50th (ft)		214			~416			~665			~664	
Queue Length 95th (ft)		280			#390			#653			#812	
Internal Link Dist (ft)		264			674			533			685	
Turn Bay Length (ft)												
Base Capacity (vph)		653			522			1136			809	
Starvation Cap Reductn		0			0			0			0	

1: Alewife Brook Pkwy & Broadway  
Lanes, Volumes, Timings

11/18/2022

Lane Group	Ø9
Detector Phase	
Switch Phase	
Minimum Initial (s)	1.0
Minimum Split (s)	19.0
Total Split (s)	19.0
Total Split (%)	14%
Maximum Green (s)	15.0
Yellow Time (s)	4.0
All-Red Time (s)	0.0
Lost Time Adjust (s)	
Total Lost Time (s)	
Lead/Lag	
Lead-Lag Optimize?	
Vehicle Extension (s)	3.0
Recall Mode	None
Walk Time (s)	7.0
Flash Dont Walk (s)	8.0
Pedestrian Calls (#/hr)	100
Act Effct Green (s)	
Actuated g/C Ratio	
v/c Ratio	
Control Delay	
Queue Delay	
Total Delay	
LOS	
Approach Delay	
Approach LOS	
90th %ile Green (s)	15.0
90th %ile Term Code	Ped
70th %ile Green (s)	15.0
70th %ile Term Code	Ped
50th %ile Green (s)	15.0
50th %ile Term Code	Ped
30th %ile Green (s)	15.0
30th %ile Term Code	Ped
10th %ile Green (s)	15.0
10th %ile Term Code	Ped
Stops (vph)	
Fuel Used(gal)	
CO Emissions (g/hr)	
NOx Emissions (g/hr)	
VOC Emissions (g/hr)	
Dilemma Vehicles (#)	
Queue Length 50th (ft)	
Queue Length 95th (ft)	
Internal Link Dist (ft)	
Turn Bay Length (ft)	
Base Capacity (vph)	
Starvation Cap Reductn	

# 1: Alewife Brook Pkwy & Broadway Lanes, Volumes, Timings

11/18/2022

Lane Group	EBL	EBT	EBR	WBL	WBT	WBR	NBL	NBT	NBR	SBL	SBT	SBR
Spillback Cap Reductn		0			0			0			0	
Storage Cap Reductn		0			0			0			0	
Reduced v/c Ratio		0.76			1.35			1.13			1.38	

## Intersection Summary

Area Type: Other

Cycle Length: 132

Actuated Cycle Length: 129.4

Natural Cycle: 150

Control Type: Actuated-Uncoordinated

Maximum v/c Ratio: 1.38

Intersection Signal Delay: 154.6

Intersection LOS: F

Intersection Capacity Utilization 87.1%

ICU Level of Service E

Analysis Period (min) 15

90th %ile Actuated Cycle: 132

70th %ile Actuated Cycle: 132

50th %ile Actuated Cycle: 130.7

30th %ile Actuated Cycle: 128

10th %ile Actuated Cycle: 124.3

~ Volume exceeds capacity, queue is theoretically infinite.

Queue shown is maximum after two cycles.

# 95th percentile volume exceeds capacity, queue may be longer.

Queue shown is maximum after two cycles.

## Splits and Phases: 1: Alewife Brook Pkwy & Broadway

Ø2 56 s	Ø9 19 s	Ø4 31 s	Ø8 26 s
Ø6 56 s			

Lane Group                      Ø9

---

Spillback Cap Reductn

Storage Cap Reductn

Reduced v/c Ratio

Intersection Summary

---

## 2: Broadway & Sunnyside Ave HCM Unsignalized Intersection Capacity Analysis



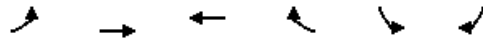













11/18/2022



Movement	EBL	EBT	WBT	WBR	SBL	SBR
Lane Configurations		↶	↷		↶	↷
Traffic Volume (veh/h)	6	500	412	20	23	22
Future Volume (Veh/h)	6	500	412	20	23	22
Sign Control		Free	Free		Stop	
Grade		0%	0%		0%	
Peak Hour Factor	0.42	0.87	0.88	0.61	0.56	0.62
Hourly flow rate (vph)	14	575	468	33	41	35
Pedestrians		23	23		23	
Lane Width (ft)		16.0	16.0		12.0	
Walking Speed (ft/s)		3.5	3.5		3.5	
Percent Blockage		3	3		2	
Right turn flare (veh)						
Median type		None	None			
Median storage (veh)						
Upstream signal (ft)			344			
pX, platoon unblocked	0.84				0.84	0.84
vC, conflicting volume	524				1134	530
vC1, stage 1 conf vol						
vC2, stage 2 conf vol						
vCu, unblocked vol	342				1065	350
tC, single (s)	4.1				6.4	6.2
tC, 2 stage (s)						
tF (s)	2.2				3.5	3.3
p0 queue free %	99				79	94
cM capacity (veh/h)	1013				196	559
Direction, Lane #	EB 1	WB 1	SB 1			
Volume Total	589	501	76			
Volume Left	14	0	41			
Volume Right	0	33	35			
cSH	1013	1700	280			
Volume to Capacity	0.01	0.29	0.27			
Queue Length 95th (ft)	1	0	27			
Control Delay (s)	0.4	0.0	22.6			
Lane LOS	A		C			
Approach Delay (s)	0.4	0.0	22.6			
Approach LOS			C			
<b>Intersection Summary</b>						
Average Delay			1.7			
Intersection Capacity Utilization			46.6%	ICU Level of Service		A
Analysis Period (min)			15			

1: Alewife Brook Pkwy & Broadway  
Lanes, Volumes, Timings

11/18/2022

												
Lane Group	EBL	EBT	EBR	WBL	WBT	WBR	NBL	NBT	NBR	SBL	SBT	SBR
Lane Configurations												
Traffic Volume (vph)	131	187	15	152	259	55	24	1120	89	20	413	86
Future Volume (vph)	131	187	15	152	259	55	24	1120	89	20	413	86
Ideal Flow (vphpl)	1900	1900	1900	1900	1900	1900	1900	1900	1900	1900	1900	1900
Lane Width (ft)	11	11	11	11	11	11	10	10	10	10	10	10
Grade (%)		0%			0%			1%			1%	
Storage Length (ft)	0		0	0		175	0		0	0		0
Storage Lanes	0		0	0		1	0		0	0		0
Taper Length (ft)	25			25			25			25		
Lane Util. Factor	0.95	0.95	0.95	0.95	0.95	0.95	0.95	0.95	0.95	0.95	0.95	0.95
Ped Bike Factor		1.00			1.00			1.00			1.00	
Fr <sub>t</sub>		0.991			0.983			0.987			0.976	
Fl <sub>t</sub> Protected		0.982			0.983			0.999			0.998	
Satd. Flow (prot)	0	3222	0	0	3329	0	0	3302	0	0	3230	0
Fl <sub>t</sub> Permitted		0.982			0.983			0.876			0.602	
Satd. Flow (perm)	0	3222	0	0	3329	0	0	2895	0	0	1949	0
Right Turn on Red			Yes			Yes			Yes			No
Satd. Flow (RTOR)		4			9			9				
Link Speed (mph)		30			30			30			30	
Link Distance (ft)		344			754			613			765	
Travel Time (s)		7.8			17.1			13.9			17.4	
Confl. Bikes (#/hr)			32			4			1			2
Peak Hour Factor	0.82	0.74	0.55	0.72	0.77	0.80	0.56	0.86	0.69	0.71	0.80	0.84
Heavy Vehicles (%)	3%	6%	9%	0%	2%	0%	0%	0%	0%	6%	0%	3%
Adj. Flow (vph)	160	253	27	211	336	69	43	1302	129	28	516	102
Shared Lane Traffic (%)												
Lane Group Flow (vph)	0	440	0	0	616	0	0	1474	0	0	646	0
Enter Blocked Intersection	No	No	No	No	No	No	No	No	No	No	No	No
Lane Alignment	Left	Left	Right	Left	Left	Right	Left	Left	Right	Left	Left	Right
Median Width(ft)		0			0			0			0	
Link Offset(ft)		0			0			0			0	
Crosswalk Width(ft)		16			16			16			16	
Two way Left Turn Lane												
Headway Factor	1.04	1.04	1.04	1.04	1.04	1.04	1.10	1.10	1.10	1.10	1.10	1.10
Turning Speed (mph)	15		9	15		9	15		9	15		9
Number of Detectors	1	1		1	1		1	1		1	1	
Detector Template	Left			Left			Left			Left		
Leading Detector (ft)	20	39		20	39		20	45		20	48	
Trailing Detector (ft)	0	33		0	33		0	39		0	42	
Detector 1 Position(ft)	0	33		0	33		0	39		0	42	
Detector 1 Size(ft)	20	6		20	6		20	6		20	6	
Detector 1 Type	Cl+Ex	Cl+Ex		Cl+Ex	Cl+Ex		Cl+Ex	Cl+Ex		Cl+Ex	Cl+Ex	
Detector 1 Channel												
Detector 1 Extend (s)	0.0	0.0		0.0	0.0		0.0	0.0		0.0	0.0	
Detector 1 Queue (s)	0.0	0.0		0.0	0.0		0.0	0.0		0.0	0.0	
Detector 1 Delay (s)	0.0	0.0		0.0	0.0		0.0	0.0		0.0	0.0	
Turn Type	Split	NA		Split	NA		Perm	NA		Perm	NA	
Protected Phases	4	4		8	8			2			6	
Permitted Phases								2			6	













1: Alewife Brook Pkwy & Broadway  
 Lanes, Volumes, Timings

11/18/2022

Lane Group	Ø9
Lane Configurations	
Traffic Volume (vph)	
Future Volume (vph)	
Ideal Flow (vphpl)	
Lane Width (ft)	
Grade (%)	
Storage Length (ft)	
Storage Lanes	
Taper Length (ft)	
Lane Util. Factor	
Ped Bike Factor	
Frt	
Flt Protected	
Satd. Flow (prot)	
Flt Permitted	
Satd. Flow (perm)	
Right Turn on Red	
Satd. Flow (RTOR)	
Link Speed (mph)	
Link Distance (ft)	
Travel Time (s)	
Confl. Bikes (#/hr)	
Peak Hour Factor	
Heavy Vehicles (%)	
Adj. Flow (vph)	
Shared Lane Traffic (%)	
Lane Group Flow (vph)	
Enter Blocked Intersection	
Lane Alignment	
Median Width(ft)	
Link Offset(ft)	
Crosswalk Width(ft)	
Two way Left Turn Lane	
Headway Factor	
Turning Speed (mph)	
Number of Detectors	
Detector Template	
Leading Detector (ft)	
Trailing Detector (ft)	
Detector 1 Position(ft)	
Detector 1 Size(ft)	
Detector 1 Type	
Detector 1 Channel	
Detector 1 Extend (s)	
Detector 1 Queue (s)	
Detector 1 Delay (s)	
Turn Type	
Protected Phases	9
Permitted Phases	

1: Alewife Brook Pkwy & Broadway  
Lanes, Volumes, Timings

11/18/2022

												
Lane Group	EBL	EBT	EBR	WBL	WBT	WBR	NBL	NBT	NBR	SBL	SBT	SBR
Detector Phase	4	4		8	8		2	2		6	6	
Switch Phase												
Minimum Initial (s)	8.0	8.0		12.0	12.0		12.0	12.0		8.0	8.0	
Minimum Split (s)	14.0	14.0		18.0	18.0		18.0	18.0		14.0	14.0	
Total Split (s)	31.0	31.0		26.0	26.0		56.0	56.0		56.0	56.0	
Total Split (%)	23.5%	23.5%		19.7%	19.7%		42.4%	42.4%		42.4%	42.4%	
Maximum Green (s)	25.0	25.0		20.0	20.0		50.0	50.0		50.0	50.0	
Yellow Time (s)	4.0	4.0		4.0	4.0		4.0	4.0		4.0	4.0	
All-Red Time (s)	2.0	2.0		2.0	2.0		2.0	2.0		2.0	2.0	
Lost Time Adjust (s)		0.0			0.0			0.0			0.0	
Total Lost Time (s)		6.0			6.0			6.0			6.0	
Lead/Lag	Lead	Lead		Lag	Lag							
Lead-Lag Optimize?	Yes	Yes		Yes	Yes							
Vehicle Extension (s)	3.0	3.0		3.0	3.0		3.0	3.0		3.0	3.0	
Recall Mode	None	None		None	None		Min	Min		Min	Min	
Walk Time (s)												
Flash Dont Walk (s)												
Pedestrian Calls (#/hr)												
Act Effct Green (s)		21.2			20.0			50.0			50.0	
Actuated g/C Ratio		0.17			0.16			0.39			0.39	
v/c Ratio		0.82			1.17			1.30			0.85	
Control Delay		64.7			141.4			174.6			48.3	
Queue Delay		0.0			0.0			0.0			0.0	
Total Delay		64.7			141.4			174.6			48.3	
LOS		E			F			F			D	
Approach Delay		64.7			141.4			174.6			48.3	
Approach LOS		E			F			F			D	
90th %ile Green (s)	25.0	25.0		20.0	20.0		50.0	50.0		50.0	50.0	
90th %ile Term Code	Max	Max		Max	Max		Max	Max		Max	Max	
70th %ile Green (s)	24.5	24.5		20.0	20.0		50.0	50.0		50.0	50.0	
70th %ile Term Code	Gap	Gap		Max	Max		Max	Max		Max	Max	
50th %ile Green (s)	21.8	21.8		20.0	20.0		50.0	50.0		50.0	50.0	
50th %ile Term Code	Gap	Gap		Max	Max		Max	Max		Hold	Hold	
30th %ile Green (s)	19.2	19.2		20.0	20.0		50.0	50.0		50.0	50.0	
30th %ile Term Code	Gap	Gap		Max	Max		Max	Max		Hold	Hold	
10th %ile Green (s)	15.7	15.7		20.0	20.0		50.0	50.0		50.0	50.0	
10th %ile Term Code	Gap	Gap		Max	Max		Max	Max		Hold	Hold	
Stops (vph)		311			381			972			448	
Fuel Used(gal)		7			18			55			11	
CO Emissions (g/hr)		489			1276			3852			745	
NOx Emissions (g/hr)		95			248			749			145	
VOC Emissions (g/hr)		113			296			893			173	
Dilemma Vehicles (#)		0			0			0			0	
Queue Length 50th (ft)		186			~320			~832			257	
Queue Length 95th (ft)		195			#355			#940			297	
Internal Link Dist (ft)		264			674			533			685	
Turn Bay Length (ft)												
Base Capacity (vph)		631			527			1135			760	
Starvation Cap Reductn		0			0			0			0	



1: Alewife Brook Pkwy & Broadway  
Lanes, Volumes, Timings

11/18/2022

Lane Group	Ø9
Detector Phase	
Switch Phase	
Minimum Initial (s)	1.0
Minimum Split (s)	19.0
Total Split (s)	19.0
Total Split (%)	14%
Maximum Green (s)	15.0
Yellow Time (s)	4.0
All-Red Time (s)	0.0
Lost Time Adjust (s)	
Total Lost Time (s)	
Lead/Lag	
Lead-Lag Optimize?	
Vehicle Extension (s)	3.0
Recall Mode	None
Walk Time (s)	7.0
Flash Dont Walk (s)	8.0
Pedestrian Calls (#/hr)	100
Act Effct Green (s)	
Actuated g/C Ratio	
v/c Ratio	
Control Delay	
Queue Delay	
Total Delay	
LOS	
Approach Delay	
Approach LOS	
90th %ile Green (s)	15.0
90th %ile Term Code	Ped
70th %ile Green (s)	15.0
70th %ile Term Code	Ped
50th %ile Green (s)	15.0
50th %ile Term Code	Ped
30th %ile Green (s)	15.0
30th %ile Term Code	Ped
10th %ile Green (s)	15.0
10th %ile Term Code	Ped
Stops (vph)	
Fuel Used(gal)	
CO Emissions (g/hr)	
NOx Emissions (g/hr)	
VOC Emissions (g/hr)	
Dilemma Vehicles (#)	
Queue Length 50th (ft)	
Queue Length 95th (ft)	
Internal Link Dist (ft)	
Turn Bay Length (ft)	
Base Capacity (vph)	
Starvation Cap Reductn	

# 1: Alewife Brook Pkwy & Broadway Lanes, Volumes, Timings

11/18/2022

Lane Group	EBL	EBT	EBR	WBL	WBT	WBR	NBL	NBT	NBR	SBL	SBT	SBR
Spillback Cap Reductn		0			0			0			0	
Storage Cap Reductn		0			0			0			0	
Reduced v/c Ratio		0.70			1.17			1.30			0.85	

## Intersection Summary

Area Type: Other

Cycle Length: 132

Actuated Cycle Length: 128.2

Natural Cycle: 150

Control Type: Actuated-Uncoordinated

Maximum v/c Ratio: 1.30

Intersection Signal Delay: 127.3      Intersection LOS: F

Intersection Capacity Utilization 88.9%      ICU Level of Service E

Analysis Period (min) 15

90th %ile Actuated Cycle: 132

70th %ile Actuated Cycle: 131.5

50th %ile Actuated Cycle: 128.8

30th %ile Actuated Cycle: 126.2

10th %ile Actuated Cycle: 122.7

~ Volume exceeds capacity, queue is theoretically infinite.  
Queue shown is maximum after two cycles.

# 95th percentile volume exceeds capacity, queue may be longer.  
Queue shown is maximum after two cycles.

## Splits and Phases: 1: Alewife Brook Pkwy & Broadway

Ø2	Ø9	Ø4	Ø8
56 s	19 s	31 s	26 s
Ø6			
56 s			

Lane Group	Ø9
Spillback Cap Reductn	
Storage Cap Reductn	
Reduced v/c Ratio	
Intersection Summary	

## 2: Broadway & Sunnyside Ave HCM Unsignalized Intersection Capacity Analysis

11/18/2022

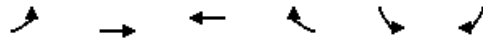

Movement	EBL	EBT	WBT	WBR	SBL	SBR
Lane Configurations		↶	↷		↶	↷
Traffic Volume (veh/h)	8	527	344	4	21	19
Future Volume (Veh/h)	8	527	344	4	21	19
Sign Control		Free	Free		Stop	
Grade		0%	0%		0%	
Peak Hour Factor	0.42	0.95	0.89	0.50	0.65	0.54
Hourly flow rate (vph)	19	555	387	8	32	35
Pedestrians		19	19		19	
Lane Width (ft)		16.0	16.0		12.0	
Walking Speed (ft/s)		3.5	3.5		3.5	
Percent Blockage		2	2		2	
Right turn flare (veh)						
Median type		None	None			
Median storage (veh)						
Upstream signal (ft)			344			
pX, platoon unblocked	0.85				0.85	0.85
vC, conflicting volume	414				1022	429
vC1, stage 1 conf vol						
vC2, stage 2 conf vol						
vCu, unblocked vol	222				937	239
tC, single (s)	4.1				6.4	6.2
tC, 2 stage (s)						
tF (s)	2.2				3.5	3.3
p0 queue free %	98				86	95
cM capacity (veh/h)	1134				237	655
Direction, Lane #	EB 1	WB 1	SB 1			
Volume Total	574	395	67			
Volume Left	19	0	32			
Volume Right	0	8	35			
cSH	1134	1700	356			
Volume to Capacity	0.02	0.23	0.19			
Queue Length 95th (ft)	1	0	17			
Control Delay (s)	0.5	0.0	17.5			
Lane LOS	A		C			
Approach Delay (s)	0.5	0.0	17.5			
Approach LOS			C			
<b>Intersection Summary</b>						
Average Delay			1.4			
Intersection Capacity Utilization			48.8%		ICU Level of Service	A
Analysis Period (min)			15			

### 3: Sunnyside Ave & Site Dr

#### HCM Unsignalized Intersection Capacity Analysis

11/18/2022



Movement	EBL	EBR	NBL	NBT	SBT	SBR
Lane Configurations						
Traffic Volume (veh/h)	0	10	5	8	30	0
Future Volume (Veh/h)	0	10	5	8	30	0
Sign Control	Stop			Free	Free	
Grade	0%			0%	0%	
Peak Hour Factor	0.92	0.92	0.92	0.92	0.92	0.92
Hourly flow rate (vph)	0	11	5	9	33	0
<b>Pedestrians</b>						
Lane Width (ft)						
Walking Speed (ft/s)						
Percent Blockage						
Right turn flare (veh)						
Median type				None	None	
Median storage (veh)						
Upstream signal (ft)						
pX, platoon unblocked						
vC, conflicting volume	52	33	33			
vC1, stage 1 conf vol						
vC2, stage 2 conf vol						
vCu, unblocked vol	52	33	33			
tC, single (s)	6.4	6.2	4.1			
tC, 2 stage (s)						
tF (s)	3.5	3.3	2.2			
p0 queue free %	100	99	100			
cM capacity (veh/h)	959	1046	1592			
<b>Direction, Lane #</b>	<b>EB 1</b>	<b>NB 1</b>	<b>SB 1</b>			
Volume Total	11	14	33			
Volume Left	0	5	0			
Volume Right	11	0	0			
cSH	1046	1592	1700			
Volume to Capacity	0.01	0.00	0.02			
Queue Length 95th (ft)	1	0	0			
Control Delay (s)	8.5	2.6	0.0			
Lane LOS	A	A				
Approach Delay (s)	8.5	2.6	0.0			
Approach LOS	A					
<b>Intersection Summary</b>						
Average Delay			2.2			
Intersection Capacity Utilization			14.9%	ICU Level of Service	A	
Analysis Period (min)			15			

### 3: Sunnyside Ave & Site Dr

#### HCM Unsignalized Intersection Capacity Analysis













11/18/2022



Movement	EBL	EBR	NBL	NBT	SBT	SBR
Lane Configurations						
Traffic Volume (veh/h)	0	10	5	8	30	0
Future Volume (Veh/h)	0	10	5	8	30	0
Sign Control	Stop			Free	Free	
Grade	0%			0%	0%	
Peak Hour Factor	0.92	0.92	0.92	0.92	0.92	0.92
Hourly flow rate (vph)	0	11	5	9	33	0
<b>Pedestrians</b>						
Lane Width (ft)						
Walking Speed (ft/s)						
Percent Blockage						
Right turn flare (veh)						
Median type				None	None	
Median storage (veh)						
Upstream signal (ft)						
pX, platoon unblocked						
vC, conflicting volume	52	33	33			
vC1, stage 1 conf vol						
vC2, stage 2 conf vol						
vCu, unblocked vol	52	33	33			
tC, single (s)	6.4	6.2	4.1			
tC, 2 stage (s)						
tF (s)	3.5	3.3	2.2			
p0 queue free %	100	99	100			
cM capacity (veh/h)	959	1046	1592			
<b>Direction, Lane #</b>	<b>EB 1</b>	<b>NB 1</b>	<b>SB 1</b>			
Volume Total	11	14	33			
Volume Left	0	5	0			
Volume Right	11	0	0			
cSH	1046	1592	1700			
Volume to Capacity	0.01	0.00	0.02			
Queue Length 95th (ft)	1	0	0			
Control Delay (s)	8.5	2.6	0.0			
Lane LOS	A	A				
Approach Delay (s)	8.5	2.6	0.0			
Approach LOS	A					
<b>Intersection Summary</b>						
Average Delay			2.2			
Intersection Capacity Utilization			14.9%	ICU Level of Service	A	
Analysis Period (min)			15			

1: Alewife Brook Pkwy & Broadway  
Lanes, Volumes, Timings

11/18/2022

												
Lane Group	EBL	EBT	EBR	WBL	WBT	WBR	NBL	NBT	NBR	SBL	SBT	SBR
Lane Configurations		↕↕			↕↕			↕↕			↕↕	
Traffic Volume (vph)	139	289	20	201	296	29	7	892	119	22	838	171
Future Volume (vph)	139	289	20	201	296	29	7	892	119	22	838	171
Ideal Flow (vphpl)	1900	1900	1900	1900	1900	1900	1900	1900	1900	1900	1900	1900
Lane Width (ft)	11	11	11	11	11	11	10	10	10	10	10	10
Grade (%)		0%			0%			1%			1%	
Storage Length (ft)	0		0	0		175	0		0	0		0
Storage Lanes	0		0	0		1	0		0	0		0
Taper Length (ft)	25			25			25			25		
Lane Util. Factor	0.95	0.95	0.95	0.95	0.95	0.95	0.95	0.95	0.95	0.95	0.95	0.95
Ped Bike Factor		1.00			1.00			1.00				
Fr <sub>t</sub>		0.991			0.989			0.983				0.972
Fl <sub>t</sub> Protected		0.985			0.983			0.999				0.999
Satd. Flow (prot)	0	3361	0	0	3350	0	0	3288	0	0	3255	0
Fl <sub>t</sub> Permitted		0.985			0.983			0.844				0.639
Satd. Flow (perm)	0	3361	0	0	3350	0	0	2778	0	0	2082	0
Right Turn on Red			Yes			Yes			Yes			No
Satd. Flow (RTOR)		4			5			12				
Link Speed (mph)		30			30			30				30
Link Distance (ft)		344			754			613				765
Travel Time (s)		7.8			17.1			13.9				17.4
Confl. Bikes (#/hr)			3			3			1			
Peak Hour Factor	0.88	0.91	0.67	0.81	0.72	0.57	0.50	0.79	0.83	0.68	0.95	0.83
Heavy Vehicles (%)	0%	2%	0%	0%	2%	0%	0%	0%	0%	0%	0%	0%
Adj. Flow (vph)	158	318	30	248	411	51	14	1129	143	32	882	206
Shared Lane Traffic (%)												
Lane Group Flow (vph)	0	506	0	0	710	0	0	1286	0	0	1120	0
Enter Blocked Intersection	No	No	No	No	No	No	No	No	No	No	No	No
Lane Alignment	Left	Left	Right	Left	Left	Right	Left	Left	Right	Left	Left	Right
Median Width(ft)		0			0			0			0	
Link Offset(ft)		0			0			0			0	
Crosswalk Width(ft)		16			16			16			16	
Two way Left Turn Lane												
Headway Factor	1.04	1.04	1.04	1.04	1.04	1.04	1.10	1.10	1.10	1.10	1.10	1.10
Turning Speed (mph)	15		9	15		9	15		9	15		9
Number of Detectors	1	1		1	1		1	1		1	1	
Detector Template	Left			Left			Left			Left		
Leading Detector (ft)	20	39		20	39		20	45		20	48	
Trailing Detector (ft)	0	33		0	33		0	39		0	42	
Detector 1 Position(ft)	0	33		0	33		0	39		0	42	
Detector 1 Size(ft)	20	6		20	6		20	6		20	6	
Detector 1 Type	Cl+Ex	Cl+Ex		Cl+Ex	Cl+Ex		Cl+Ex	Cl+Ex		Cl+Ex	Cl+Ex	
Detector 1 Channel												
Detector 1 Extend (s)	0.0	0.0		0.0	0.0		0.0	0.0		0.0	0.0	
Detector 1 Queue (s)	0.0	0.0		0.0	0.0		0.0	0.0		0.0	0.0	
Detector 1 Delay (s)	0.0	0.0		0.0	0.0		0.0	0.0		0.0	0.0	
Turn Type	Split	NA		Split	NA		Perm	NA		Perm	NA	
Protected Phases	4	4		8	8			2			6	
Permitted Phases							2			6		

# 1: Alewife Brook Pkwy & Broadway

## Lanes, Volumes, Timings













11/18/2022

Lane Group	Ø9
Lane Configurations	
Traffic Volume (vph)	
Future Volume (vph)	
Ideal Flow (vphpl)	
Lane Width (ft)	
Grade (%)	
Storage Length (ft)	
Storage Lanes	
Taper Length (ft)	
Lane Util. Factor	
Ped Bike Factor	
Frt	
Flt Protected	
Satd. Flow (prot)	
Flt Permitted	
Satd. Flow (perm)	
Right Turn on Red	
Satd. Flow (RTOR)	
Link Speed (mph)	
Link Distance (ft)	
Travel Time (s)	
Confl. Bikes (#/hr)	
Peak Hour Factor	
Heavy Vehicles (%)	
Adj. Flow (vph)	
Shared Lane Traffic (%)	
Lane Group Flow (vph)	
Enter Blocked Intersection	
Lane Alignment	
Median Width(ft)	
Link Offset(ft)	
Crosswalk Width(ft)	
Two way Left Turn Lane	
Headway Factor	
Turning Speed (mph)	
Number of Detectors	
Detector Template	
Leading Detector (ft)	
Trailing Detector (ft)	
Detector 1 Position(ft)	
Detector 1 Size(ft)	
Detector 1 Type	
Detector 1 Channel	
Detector 1 Extend (s)	
Detector 1 Queue (s)	
Detector 1 Delay (s)	
Turn Type	
Protected Phases	9
Permitted Phases	



1: Alewife Brook Pkwy & Broadway  
Lanes, Volumes, Timings

11/18/2022

												
Lane Group	EBL	EBT	EBR	WBL	WBT	WBR	NBL	NBT	NBR	SBL	SBT	SBR
Detector Phase	4	4		8	8		2	2		6	6	
Switch Phase												
Minimum Initial (s)	8.0	8.0		12.0	12.0		12.0	12.0		8.0	8.0	
Minimum Split (s)	14.0	14.0		18.0	18.0		18.0	18.0		14.0	14.0	
Total Split (s)	31.0	31.0		26.0	26.0		56.0	56.0		56.0	56.0	
Total Split (%)	23.5%	23.5%		19.7%	19.7%		42.4%	42.4%		42.4%	42.4%	
Maximum Green (s)	25.0	25.0		20.0	20.0		50.0	50.0		50.0	50.0	
Yellow Time (s)	4.0	4.0		4.0	4.0		4.0	4.0		4.0	4.0	
All-Red Time (s)	2.0	2.0		2.0	2.0		2.0	2.0		2.0	2.0	
Lost Time Adjust (s)		0.0			0.0			0.0			0.0	
Total Lost Time (s)		6.0			6.0			6.0			6.0	
Lead/Lag	Lead	Lead		Lag	Lag							
Lead-Lag Optimize?	Yes	Yes		Yes	Yes							
Vehicle Extension (s)	3.0	3.0		3.0	3.0		3.0	3.0		3.0	3.0	
Recall Mode	None	None		None	None		Min	Min		Min	Min	
Walk Time (s)												
Flash Dont Walk (s)												
Pedestrian Calls (#/hr)												
Act Effct Green (s)		22.6			20.0			50.0			50.0	
Actuated g/C Ratio		0.17			0.15			0.39			0.39	
v/c Ratio		0.86			1.36			1.19			1.39	
Control Delay		66.9			216.4			131.5			217.8	
Queue Delay		0.0			0.0			0.0			0.0	
Total Delay		66.9			216.4			131.5			217.8	
LOS		E			F			F			F	
Approach Delay		66.9			216.4			131.5			217.8	
Approach LOS		E			F			F			F	
90th %ile Green (s)	25.0	25.0		20.0	20.0		50.0	50.0		50.0	50.0	
90th %ile Term Code	Max	Max		Max	Max		Max	Max		Max	Max	
70th %ile Green (s)	25.0	25.0		20.0	20.0		50.0	50.0		50.0	50.0	
70th %ile Term Code	Max	Max		Max	Max		Max	Max		Max	Max	
50th %ile Green (s)	24.1	24.1		20.0	20.0		50.0	50.0		50.0	50.0	
50th %ile Term Code	Gap	Gap		Max	Max		Max	Max		Max	Max	
30th %ile Green (s)	21.4	21.4		20.0	20.0		50.0	50.0		50.0	50.0	
30th %ile Term Code	Gap	Gap		Max	Max		Max	Max		Max	Max	
10th %ile Green (s)	17.6	17.6		20.0	20.0		50.0	50.0		50.0	50.0	
10th %ile Term Code	Gap	Gap		Max	Max		Max	Max		Max	Max	
Stops (vph)		421			403			831			781	
Fuel Used(gal)		10			28			37			56	
CO Emissions (g/hr)		674			1992			2567			3928	
NOx Emissions (g/hr)		131			388			499			764	
VOC Emissions (g/hr)		156			462			595			910	
Dilemma Vehicles (#)		0			0			0			0	
Queue Length 50th (ft)		217			~421			~698			~672	
Queue Length 95th (ft)		283			#393			#681			#816	
Internal Link Dist (ft)		264			674			533			685	
Turn Bay Length (ft)												
Base Capacity (vph)		651			521			1079			803	
Starvation Cap Reductn		0			0			0			0	

1: Alewife Brook Pkwy & Broadway  
Lanes, Volumes, Timings

11/18/2022

Lane Group	Ø9
Detector Phase	
Switch Phase	
Minimum Initial (s)	1.0
Minimum Split (s)	19.0
Total Split (s)	19.0
Total Split (%)	14%
Maximum Green (s)	15.0
Yellow Time (s)	4.0
All-Red Time (s)	0.0
Lost Time Adjust (s)	
Total Lost Time (s)	
Lead/Lag	
Lead-Lag Optimize?	
Vehicle Extension (s)	3.0
Recall Mode	None
Walk Time (s)	7.0
Flash Dont Walk (s)	8.0
Pedestrian Calls (#/hr)	100
Act Effct Green (s)	
Actuated g/C Ratio	
v/c Ratio	
Control Delay	
Queue Delay	
Total Delay	
LOS	
Approach Delay	
Approach LOS	
90th %ile Green (s)	15.0
90th %ile Term Code	Ped
70th %ile Green (s)	15.0
70th %ile Term Code	Ped
50th %ile Green (s)	15.0
50th %ile Term Code	Ped
30th %ile Green (s)	15.0
30th %ile Term Code	Ped
10th %ile Green (s)	15.0
10th %ile Term Code	Ped
Stops (vph)	
Fuel Used(gal)	
CO Emissions (g/hr)	
NOx Emissions (g/hr)	
VOC Emissions (g/hr)	
Dilemma Vehicles (#)	
Queue Length 50th (ft)	
Queue Length 95th (ft)	
Internal Link Dist (ft)	
Turn Bay Length (ft)	
Base Capacity (vph)	
Starvation Cap Reductn	

1: Alewife Brook Pkwy & Broadway  
Lanes, Volumes, Timings

11/18/2022

Lane Group	EBL	EBT	EBR	WBL	WBT	WBR	NBL	NBT	NBR	SBL	SBT	SBR
Spillback Cap Reductn		0			0			0			0	
Storage Cap Reductn		0			0			0			0	
Reduced v/c Ratio		0.78			1.36			1.19			1.39	

Intersection Summary

Area Type:	Other
Cycle Length:	132
Actuated Cycle Length:	129.6
Natural Cycle:	150
Control Type:	Actuated-Uncoordinated
Maximum v/c Ratio:	1.39
Intersection Signal Delay:	165.8
Intersection Capacity Utilization:	87.3%
Analysis Period (min):	15
90th %ile Actuated Cycle:	132
70th %ile Actuated Cycle:	132
50th %ile Actuated Cycle:	131.1
30th %ile Actuated Cycle:	128.4
10th %ile Actuated Cycle:	124.6
~	Volume exceeds capacity, queue is theoretically infinite. Queue shown is maximum after two cycles.
#	95th percentile volume exceeds capacity, queue may be longer. Queue shown is maximum after two cycles.

Splits and Phases: 1: Alewife Brook Pkwy & Broadway

Ø2 56 s	Ø9 19 s	Ø4 31 s	Ø8 26 s
Ø6 56 s			

Lane Group                      Ø9

---

Spillback Cap Reductn

Storage Cap Reductn

Reduced v/c Ratio

Intersection Summary

---

## 2: Broadway & Sunnyside Ave HCM Unsignalized Intersection Capacity Analysis

11/18/2022

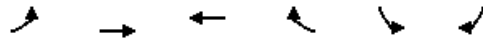

Movement	EBL	EBT	WBT	WBR	SBL	SBR
Lane Configurations		↶	↷		↶	↷
Traffic Volume (veh/h)	5	500	412	26	28	25
Future Volume (Veh/h)	5	500	412	26	28	25
Sign Control		Free	Free		Stop	
Grade		0%	0%		0%	
Peak Hour Factor	0.42	0.87	0.88	0.61	0.56	0.62
Hourly flow rate (vph)	12	575	468	43	50	40
Pedestrians		23	23		23	
Lane Width (ft)		16.0	16.0		12.0	
Walking Speed (ft/s)		3.5	3.5		3.5	
Percent Blockage		3	3		2	
Right turn flare (veh)						
Median type		None	None			
Median storage (veh)						
Upstream signal (ft)			344			
pX, platoon unblocked	0.84				0.84	0.84
vC, conflicting volume	534				1134	536
vC1, stage 1 conf vol						
vC2, stage 2 conf vol						
vCu, unblocked vol	354				1066	355
tC, single (s)	4.1				6.4	6.2
tC, 2 stage (s)						
tF (s)	2.2				3.5	3.3
p0 queue free %	99				75	93
cM capacity (veh/h)	1003				196	555
Direction, Lane #	EB 1	WB 1	SB 1			
Volume Total	587	511	90			
Volume Left	12	0	50			
Volume Right	0	43	40			
cSH	1003	1700	275			
Volume to Capacity	0.01	0.30	0.33			
Queue Length 95th (ft)	1	0	34			
Control Delay (s)	0.3	0.0	24.3			
Lane LOS	A		C			
Approach Delay (s)	0.3	0.0	24.3			
Approach LOS			C			
<b>Intersection Summary</b>						
Average Delay			2.0			
Intersection Capacity Utilization			46.0%	ICU Level of Service		A
Analysis Period (min)			15			

### 3: Sunnyside Ave & Site Dr

#### HCM Unsignalized Intersection Capacity Analysis

11/18/2022



Movement	EBL	EBR	NBL	NBT	SBT	SBR
Lane Configurations						
Traffic Volume (veh/h)	0	8	10	26	20	0
Future Volume (Veh/h)	0	8	10	26	20	0
Sign Control	Stop			Free	Free	
Grade	0%			0%	0%	
Peak Hour Factor	0.92	0.92	0.92	0.92	0.92	0.92
Hourly flow rate (vph)	0	9	11	28	22	0
<b>Pedestrians</b>						
Lane Width (ft)						
Walking Speed (ft/s)						
Percent Blockage						
Right turn flare (veh)						
Median type				None	None	
Median storage (veh)						
Upstream signal (ft)						
pX, platoon unblocked						
vC, conflicting volume	72	22	22			
vC1, stage 1 conf vol						
vC2, stage 2 conf vol						
vCu, unblocked vol	72	22	22			
tC, single (s)	6.4	6.2	4.1			
tC, 2 stage (s)						
tF (s)	3.5	3.3	2.2			
p0 queue free %	100	99	99			
cM capacity (veh/h)	926	1055	1593			
<b>Direction, Lane #</b>	<b>EB 1</b>	<b>NB 1</b>	<b>SB 1</b>			
Volume Total	9	39	22			
Volume Left	0	11	0			
Volume Right	9	0	0			
cSH	1055	1593	1700			
Volume to Capacity	0.01	0.01	0.01			
Queue Length 95th (ft)	1	1	0			
Control Delay (s)	8.4	2.1	0.0			
Lane LOS	A	A				
Approach Delay (s)	8.4	2.1	0.0			
Approach LOS	A					
<b>Intersection Summary</b>						
Average Delay			2.2			
Intersection Capacity Utilization			18.6%	ICU Level of Service	A	
Analysis Period (min)			15			